

Product Guide

Making life easier for the HVAC/R engineer

Contents

01 Condensate Removal Pumps		07 Support & Mounting		12 Tool Storage & bags	
Silent+ Mini Pumps (The World's Quietest)	6-11	Rubber Feet	112-114	Veto EVO System	176-178
Mini Pumps	12-16	PVC Mounting Blocks	115	Veto Pro Pac Tool Bags	175-185
Peristaltic Pumps	17-19	Support Feet	116-118	Norwalk Bags	186
Tank Pumps	20-27	Heat Pump Kit	119		
Supermarket Pumps	28-32	Frames	120-123	13 Lighting & Torches	
Boiler Pumps	33-36	Wall Brackets	124-127	Site Lights	188-190
		Roof Brackets	128	Inspection Lights	191-201
02 Service & Tooling		Anti-Vibration Dampers	129-131	Head Torches	202-205
Hand Tools	38-51	Anti vibration pads & strips	132	Flashlights	206-207
Knives / Cutters	52-54	Trays	133	ATEX Lights	208-210
Lifters	55-56	Accessories	134		
		08 Condensate Management & Drainage		14 PPE	
03 Recovery, Vacuum & Charging		Vinyl Tubes	136	Safety Glasses	212-214
Recovery Units	58-61	Rigid Pipe	137	Cut & Impact-Resistant Gloves	215
Vacuum Pumps	62-64	Flexible Tubes	138	Zipped Jumpers	216
Ultimate Hi-Flow	65-71	Drainage Fittings & Spares	139		
Hose	72-76	Pipelounge	140-141	The Brands	218
Kits	77	Connectors	142-143		
Manifolds	78-79	Pipe Support Clips	144-150		
Gauges & Oils	80-81	Tape	151		
Thermometers	82	Drain Cleaner & Unblocker Range	152		
Scales	83-84				
Nitrogen	85-87	09 Cages & Acoustic Housing			
Accessories	88	Design Box	154		
		Protection Guards	155		
04 Brazing & Welding		Acoustic Guards	156		
Brazing & Welding Kits	90				
Brazing & Welding Torches	91-93	10 Electrical			
Heat Blockers & Accessories	94	Isolators	158-159		
		Accessories	160		
05 Leak Detection					
Refrigerant	96-97	11 Maintenance			
Sprays	98	Evaporator	162-163		
Ultra Violet	99-102	Condenser	164		
		Universal	165		
06 Brass & Copper Fittings		Drain Maintenance	166		
About C&D	104-105	Refrigeration & Ice Machines	167		
Service Kits	106-108	Specialist Chemicals	168-171		
Smartlock	109-110	Accessories	172-174		





**ASPEN
PUMPS
GROUP**

Aspen Pumps Group is unique in its global reach, trading in over 100 countries worldwide.

However, Aspen is not purely an export business; it is a multi-national organisation with sales teams across the world with offices in 4 continents. Our continuous investment in people and warehouse infrastructure means we are a leader in the provision of service, quality and customer support. This approach to business means we have the most extensive and well supported wholesaler partnership network in the world.

The Aspen Pumps Group takes pride in its business performance, celebrating success in its core capabilities of Enterprise, Innovation and International Trade through winning Queen's Awards for each (2009, 2014, 2019).

Aspen Pumps Group – a global award winning business.

Ropemakers, Hailsham UK:

Our new 33,500sq ft warehouse ready to house our ever expanding portfolio of products. Just one of our many warehouses across the globe designed to give you the best in customer service.

Information correct at time of going to press. Not all products are available in all regions.

01

CONDENSATE REMOVAL PUMPS

Silent+ Mini Pumps	6-11
Mini Pumps	12-16
Peristaltic Pumps	17-19
Tank Pumps	20-27
Supermarket Pumps	28-32
Boiler Pumps	33-36



**ASPEN
PUMPS
GROUP**

Silent+ Mini Pumps

Today end users are demanding quieter air conditioning pumps in areas such as offices and hotels. Silent+ pumps are perfectly suited for these types of applications. The Silent+ range is designed around a 'total system approach' to ensure they operate as quietly as possible without compromising on performance.



Silent+ Mini White



Silent+ Mini Lime®



Silent+ Mini Aqua®



Silent+ Mini Orange®

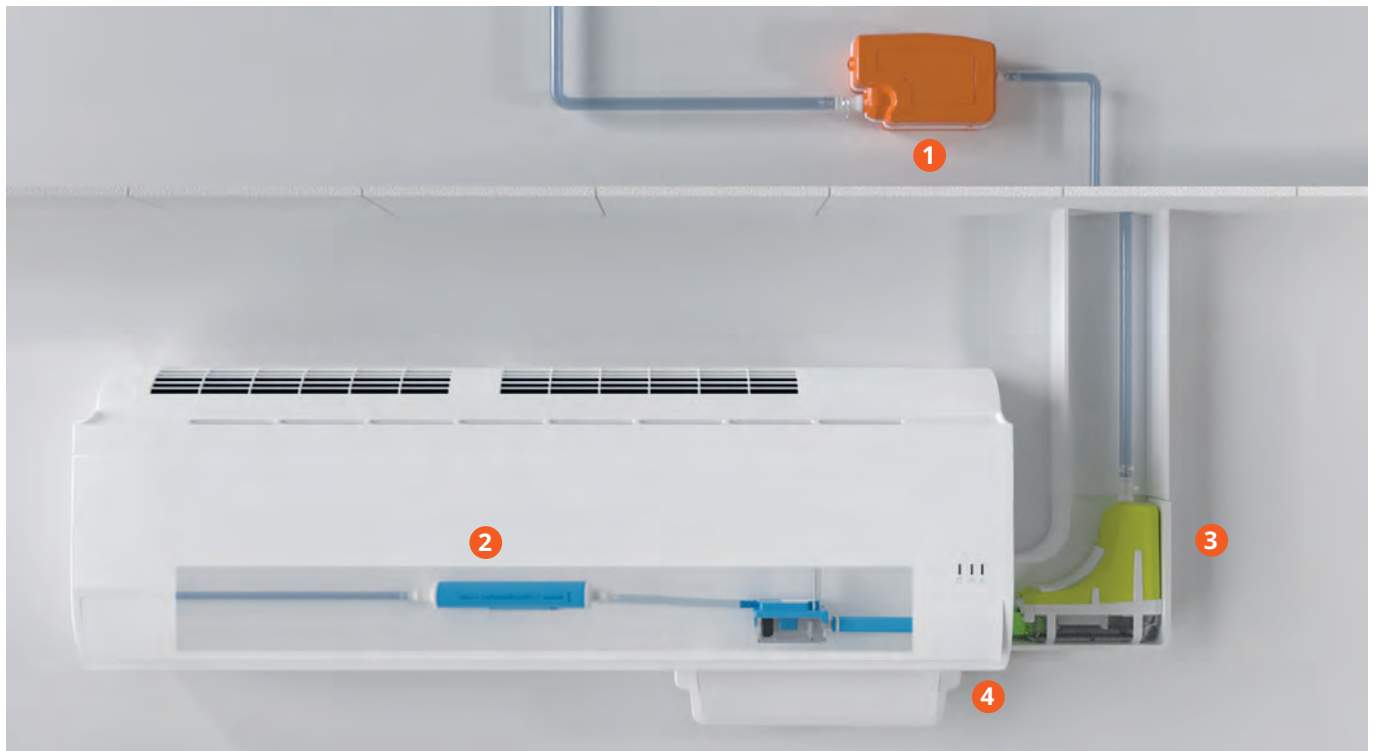

1 In the ceiling (Note: anti vibration bracket) 2 In the AC unit 3 Within the trunking 4 Under the unit

01

CONDENSATE REMOVAL PUMPS

SILENT+ MINI



Silent+® Mini Lime™



CONDENSATE REMOVAL PUMP

The new and improved 5th gen Silent+ Mini Lime – just 16dB(A) this is the quietest and most versatile of elbow pumps. Simple and flexible to install. The proven technology delivers an impressive flow rate and lower power consumption. All round maximum performance, on-demand power, near-silent operation, optimum reliability and increased energy efficiency.

- 40L/h max. flow
- 15m max. rec. head
- 16dB(A) @ 1m

Key Features

- Backwards compatible Plug & Play cable
- Fits all popular trunking systems
- Quick install – no longer need for a damper, anti-siphon
- 40L/h flow rate and up to 10 x lower power consumption

Suitability

- Up to 46kW / 157,000Btu/h
- High wall split systems
- Left or right install with range of trunking systems
- **Perfect for...**
Commercial and domestic use where silence is important

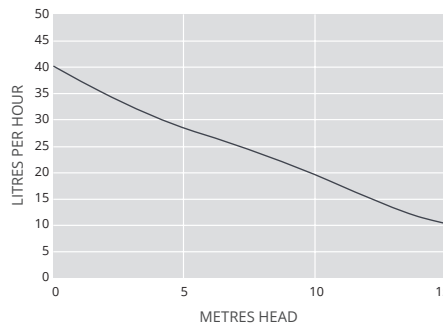
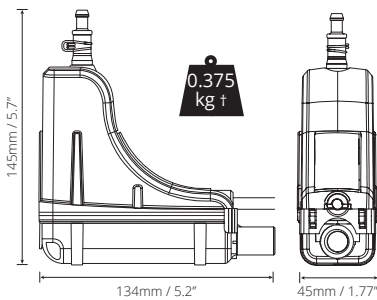

SYSTEM OPTIONS		
System	Colour	Part No.
Slimline	Ivory	FP3312/5
	White	FP3319/5
EuroSplit	Pure White	FP3470/5
	Signal White	FP3471/5
	Light Ivory	FP3472/5
	Anthracite	FP3473/5
O-Ducting	Black	FP3474/5
	White	FP3327/5 ††
S-Ducting	White	FP3320/5 †
Inoac	White	FP3321/5
Silent+ Mini Lime Replacement†		FP3322/5

Univolt 100-250 VAC 50-60Hz	
Max. flow	40L/h @ 0m head
Max. rec. head	15m
dB(A) @ 1m	16*
Power supply	100-250 VAC, 0.18A, 2.1W, 50/60Hz
Rated	Continuous
Class	II
Max. unit output	Up to 46kW / 157000Btu/h
Max. ambient temp	40°C
Inlet/Outlet connections	Inlet o/d: Ø16mm Outlet o/d: Ø6mm
IP Protection	IP24
Safety switch	5.0A N.C. (Normally Closed)
Self priming	✓

IN THE BOX
Silent+ Mini Lime pump (including 1.5m Plug & Play cable) • 500mm Lime green inlet hose 14mm ID • 40mm Vinyl breather tube 6mm ID • Elbow front and back • 800mm trunking front and back • Internal trunking sleeve (Slimline system only) • Gasket (Slimline, S-Ducting and Inoac systems only) • Ceiling plate • Drain connector kit • Fixing kit • Quick Start Guide

SUGGESTED ACCESSORIES	
Description	Part No.
1 Amp Fuse	FP2620
Tube To Soil Stack Adaptor	FP2038
Vinyl Tube Braided 1/4" (6mm)	AX5100

† Pump only – no trunking included.
‡ FP3320/5 trunking system is SpeediDuct® compatible.
†† FP3327/5 trunking system is Optimal® compatible.
(SpeediDuct® & Optimal Duct are registered trademarks of Castel Engineering).

Download manual at aspenspumps.com

Watch installation video at aspenspumps.com

*Assuming solid wall construction with a 2kW unit.

Information correct at time of going to press. Not all products are available in all regions.





THE NEW SILENT+ MINI LIME QUIETLY BRILLIANT



Simple & faster install.

No need for a damper, anti-siphon, buttons or lights.
No need for a Maxi Lime – this pump is a Mini and Maxi all-in-one.

Fits all trunking systems.

Plus, our Kwik Fix range is available in three colours (white, cream, black).

Plug & Play. Backwards compatible. Perfect for replacement installations.

Replacement pump available, alongside the complete system.

Near-silent operation.

As low as 16dB(A)@1m.
Variable speed, on demand power, no-touching parts = silence.

Proven tech. Same tech as our best-selling Silent+ Mini White. Only works when it needs to. Up to 10 x lower power consumption.

An impressive flow rate of up to 40 l/h, larger tank and head capability.

Satisfaction guaranteed. All backed with a three year guarantee.

Information correct at time of going to press. Not all products are available in all regions.



Silent+ Mini Orange™



CONDENSATE REMOVAL PUMP

The world's No.1 Orange mini pump is now better than ever. Using our proven 5th Gen Technology, the Silent+ Mini Orange boasts sound levels as low as 16dB(A)*. So quiet it eliminates the need for additional noise or vibration dampers. Capacitance sensor technology, provides intelligent, adaptive flow rates. Quietly brilliant.



35L/h max. flow



10m max. rec. head



As low as 16dB(A)*

Key Features

- Proven 5th Gen Technology: Capacitance Sensing & Rotary Diaphragm = Silence & Power
- Low maintenance
- Plug & Play**
- 3 year warranty

Suitability

- Up to 40kW / 136,000Btu/h
- Ducted units; floor standing & chassis units; high wall split systems
- **Perfect for...** small commercial and residential units

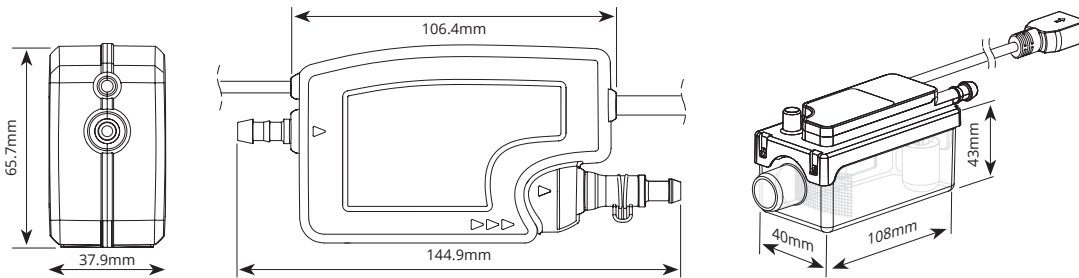

0.391 kg

SPECIFICATIONS

Max. flow	35L/h @ 0m head
Max. rec. head	10m
Max. suction lift	1.5m
Min. dB(A) @ 1m	16dB(A)*
Power supply	100-250VAC, 0.18A, 2.4W, 50/60 Hz
Rated	Continuous
Class	II □
Max. unit output	40kW / 136,000Btu/h
Max. ambient temp	40°C (104°F)
IP Protection	IP24
Inlet o/d	Ø16mm (5/8")
Outlet o/d	Ø6mm (1/4")
Safety switch	5.0 A Normally closed
Self priming	✓

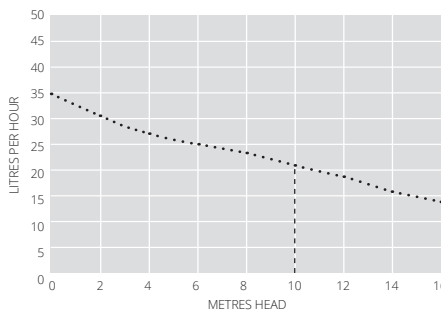

OPTIONS

Silent+ Mini Orange FP3430

IN THE BOX

Silent+ Mini Orange 5th Gen pump • Reservoir (inc. filter and lid) • 1.5m Plug & play cable** • 1.5m clear PVC tube • 150mm clear vent hose • 220mm Orange inlet hose • Drain connector kit: straight connector and rubber elbow • Quick start guide

SUGGESTED ACCESSORIES

Description	Part No.
Hose Clamp 10.1 dia. (x10)	B3340
S+ Mini Pump spare filters (x10)	FP3330
Barbed anti-siphon device	FP3336/1
Reservoir copper mesh filter (x10)	FP3460
Universal fixing bracket	FP3463
Mini Pump reservoir kit	FP3461

*assuming solid wall construction with a 2kW unit

**not backwards compatible

Download full manual at aspenspumps.com

Information correct at time of going to press. Not all products are available in all regions.



Silent+® Mini Aqua™



CONDENSATE REMOVAL PUMP

The Silent+ Mini Aqua keeps its sleek and slender form offering unparalleled installation flexibility. It fits neatly into trunking and inside mini split units. Packed with our proven 5th Gen Technology, it's unbeatable silence – a barely audible 16dB(A)*, combined with intelligent, adaptive flow rates – further extends pump life, maximises reliability and improves energy efficiency. Quietly brilliant.

- 35L/h max. flow
- 10m max. rec. head
- As low as 16dB(A)*

Key Features

- Slim profile
- Proven 5th Gen Technology: Capacitance Sensing & Rotary Diaphragm = Silence & Power
- Low maintenance
- Plug & Play**
- 3 year warranty

Suitability

- Up to 40kW / 136,000Btu/h
- Ducted units; floor standing & chassis units; high wall mini split systems
- **Perfect for...** smaller commercial and domestic applications, where silence is needed

0.408 kg

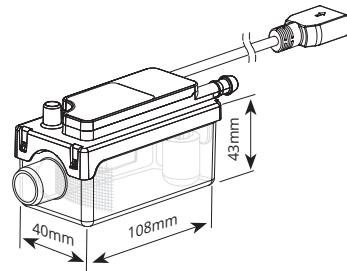
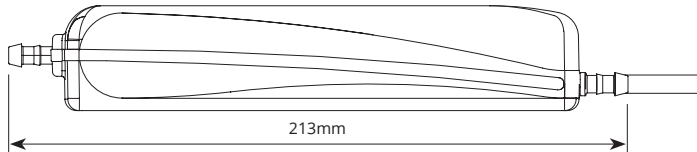
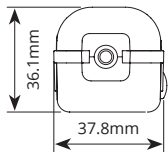

SPECIFICATIONS	
Max. flow	35L/h @ 0m head
Max. rec. head	10m
Max. suction lift	1.5m
Min. dB(A) @ 1m	16dB(A)*
Power supply	100-250VAC, 0.18A, 2.4W, 50/60 Hz
Rated	Continuous
Class	II
Max. unit output	40kW / 136,000Btu/h
Max. ambient temp	40°C (104°F)
IP Protection	IP24
Inlet o/d	Ø16mm (5/8")
Outlet o/d	Ø6mm (1/4")
Safety switch	5.0 A Normally closed
Self priming	✓

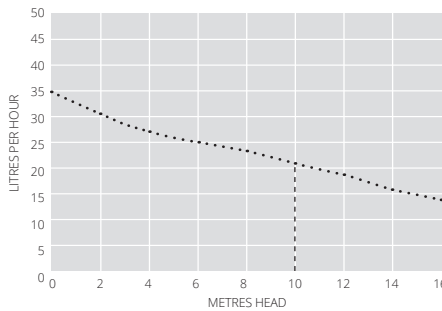

OPTIONS	
Silent+ Mini Aqua	FP3420

IN THE BOX	
Silent+ Mini Aqua 5th Gen pump • Reservoir (inc. filter and lid) • 1.5m Plug & play cable**	
• 1.5m clear PVC tube • 150mm clear vent hose	
• 220mm blue inlet hose • Drain connector kit: straight connector and rubber elbow	
• Quick start guide	

SUGGESTED ACCESSORIES		
Description		Part No.
Hose Clamp 10.1 dia. (x10)		B3340
S+ Mini Pump spare filters (x10)		FP3330
Barbed anti-siphon device		FP3336/1
Reservoir copper mesh filter (x10)		FP3460
Universal fixing bracket		FP3463
Mini Pump reservoir kit		FP3461

* assuming solid wall construction with a 2kW unit
 ** not backwards compatible

Download full manual at aspenspumps.com

Information correct at time of going to press. Not all products are available in all regions.



Silent+® Mini White™

CONDENSATE REMOVAL PUMP

Incredibly quiet, easy to install and maintain, the Silent+ Mini White has been designed to fit either side of the evaporator unit. The reservoir is simple to unclip for cleaning and maintenance.



45L/h max. flow



10m max. rec. head
(flow rate 23L/h)



As low as 16dB(A)
when operating

Key Features

- Ultra quiet operation
- Extra quick to fit
- Compact & discreet
- Removable reservoir

Suitability

- Up to 16kW / 54,000Btu/h
- High wall mini split systems
- **Perfect for...** domestic environments where minimising audible noise is crucially important

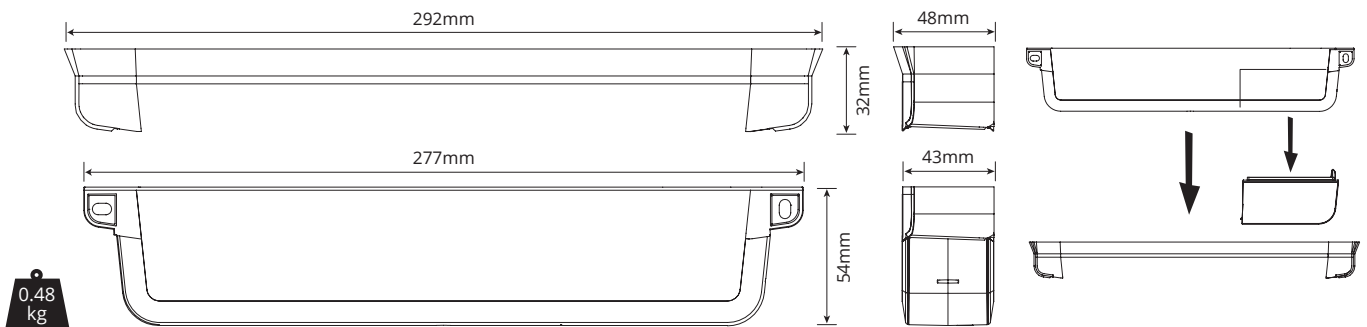

SPECIFICATIONS

Max. flow	45L/h @ 0m head
Max. rec. head	10m
Min. dB(A) @ 1m	16dB(A)
Power supply	230 VAC, 50-60 Hz, 0,18 A, 2.1 W
Rated	Continuous
Class	II <input type="checkbox"/>
Max. unit output	16kW (54,000Btu/h)
Max. ambient temp	40°C (104°F)
IP Protection	IP24
Inlet o/d	16mm (5/8") - 26mm (1")
Outlet o/d	Ø6mm (1/4")
Safety switch	5.0 A NO & NC contacts
Thermal protection	✓
Self priming	✓

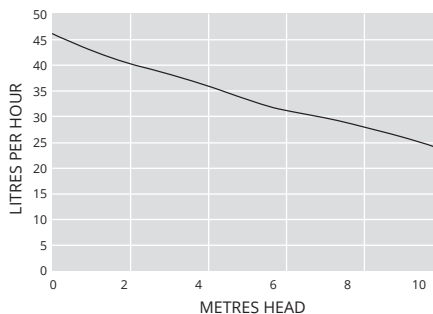

SUGGESTED ACCESSORIES

Description	Part No.
1 Amp Fuse	FP2620
Tube To Soil Stack Adaptor	FP2038

OPTIONS

Silent+ Mini White (Europe)	FP3450
-----------------------------	--------

IN THE BOX

Silent+ Mini White pump (incl. hard wired 1m power cable) • Fitting template • Outlet elbow • Screw caps • Spacer • Installation manual

Download manual at aspenspumps.com

Ensure ALL cleaning chemicals are flushed out of the reservoir after use.

Information correct at time of going to press. Not all products are available in all regions.

Mini Pumps

When it comes to dependable condensate removal, Aspen's Mini Pump range delivers performance you can trust. Designed to suit the majority of HVAC applications, these compact pumps are the go-to choice for installers and engineers who value reliability, ease of installation, and solid performance.



Mini Blanc



Mini Lime™



Mini Aqua™



Mini Orange™



1 In the ceiling 2 In the AC unit 3 Within the trunking 4 Under the unit

Information correct at time of going to press. Not all products are available in all regions.

01

CONDENSATE
REMOVAL PUMPS

MINI



Mini Lime™

CONDENSATE REMOVAL PUMP

The New Mini Lime is Aspen's all-in-one elbow mini pump. Complete with a 620mm length of EuroSplit trunking – less waste and better value! **Need more trunking options and the world's quietest mini pump? Please see our Silent+ Mini Lime.**



20L/h max. flow



15m max. rec. head



19dB(A) @ 1m

Key Features

- Plug & Play
- Fits all popular trunking systems
- Quick install
- 2 year warranty

Suitability

- Up to 26kW / 90,000Btu/h
- High wall split systems
- Left or right install
- **Perfect for...**
Commercial and domestic use

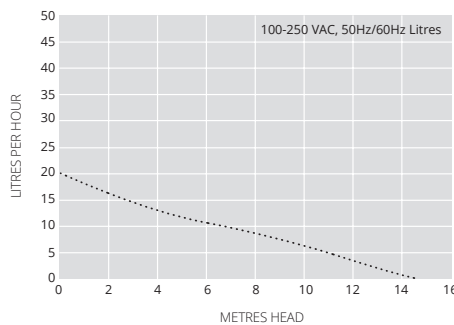
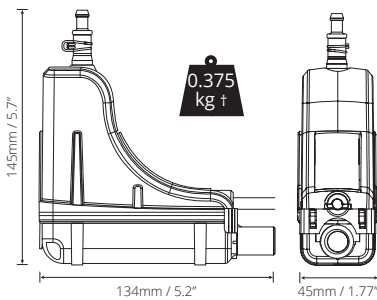

Univolt 100-250 VAC 50-60Hz	
Max. flow	20L/h @ 0m head
Max. rec. head	15m
dB(A) @ 1m	19
Power supply	100-250 VAC, 0.18A, 2.1W, 50/60Hz
Rated	Continuous
Class	II
Max. unit output	26kW (90,000Btu/h)
Max. ambient temp	40°C
Inlet/Outlet connections	Inlet o/d: Ø16mm Outlet o/d: Ø6mm
IP Protection	IP24
Safety switch	5.0A N.C. (Normally Closed)
Self priming	✓

† Pump only – no trunking included.

SYSTEM OPTIONS		
System	Colour	Part No.
EuroSplit (620mm length)	Pure White	FP3580
	Signal White	FP3581
	Light Ivory	FP3582
	Anthracite	FP3583
	Black	FP3584
Ersatz für Mini Lime†		FP3579

For further trunking options, see our Silent+ Mini Lime range.

IN THE BOX
Mini Lime pump (including 1.5m Plug & Play cable) • 220mm inlet hose 14mm ID • 40mm Vinyl breather tube 6mm ID • Elbow front and back • 620mm trunking front and back • Ceiling plate • Drain connector kit • Fixing kit • Quick start guide

SUGGESTED ACCESSORIES		
Description		Part No.
Hose Clamp 10.1 dia. (x10)		B3340
S+ Mini Pump spare filters (x10)		FP3330
Barbed anti-siphon device		FP3336/1
Mini Lime spares kit		FP3328

Download full manual at aspenspumps.com

Watch installation video at aspenspumps.com

Information correct at time of going to press. Not all products are available in all regions.





Mini Aqua™

CONDENSATE REMOVAL PUMP

The world's slimmest condensate removal pump is designed to fit where other's can't!

For users who demand excellence, upgrade to the Silent+ range, the world's quietest mini pumps.



12L/h max. flow



10m max. rec. head
(flow rate 6L/h)



21dB(A) @ 1m

Key Features

- Ultra slim
- High performance
- Plug & Play
- Anti siphon device

Suitability

- Up to 16kW / 54,000Btu/h
- High wall mini split systems; Ducted units; Floor standing & Chassis units
- **Perfect for...** installing directly inside the unit



0.18
kg †

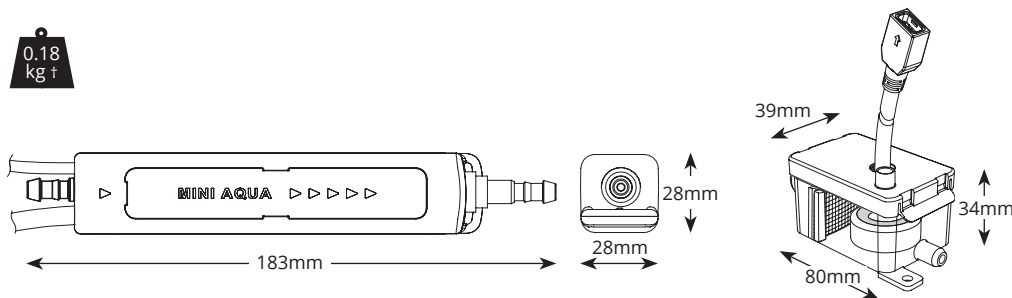

@ 230 VAC 50Hz

Max. flow	12L/h @ 0m head
Max. rec. head	10m
Max. suction lift	1.5m
dB(A) @ 1m	21dB(A)
Power supply	230 VAC, 50-60Hz, 0.11A, 16W
Rated	Non continuous
Class	II □
Max. unit output	16kW (54,000 Btu/h)
Max. water temp	40°C (104°F)
Discharge tube	6mm ID
IP Protection	IP24
Safety switch	3.0A Normally closed
Thermal protection	✓
Fully potted	✓
Self priming	✓

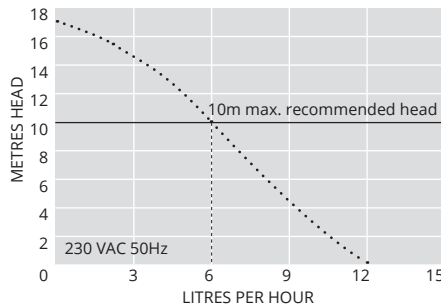

OPTIONS

Mini Aqua FP2406/2

† Pump only

📖 Download manual at aspenspumps.com

▶ Watch installation video at aspenspumps.com

SUGGESTED ACCESSORIES

Description	Part No.
1 Amp Fuse	FP2620
Tube To Soil Stack Adaptor	FP2038
Vinyl Tube Braided 1/4" (6mm)	AX5100

IN THE BOX

Mini Aqua pump • 1.5m Plug & Play power cable • Reservoir (inc. filter, float, lid) • 150mm Vinyl breather tube 6mm ID • Anti siphon device • 1.5m Suction tube 6mm ID • 220mm Blue inlet hose 14mm ID • Drain connector kit • Fixing kit • Quick Start Guide

📖 Download full manual at aspenspumps.com

▶ Watch installation video at aspenspumps.com

Information correct at time of going to press. Not all products are available in all regions.

Mini Orange™



CONDENSATE REMOVAL PUMP

The Mini Orange – Aspen as you know it. Quiet, reliable, and built for performance. Designed to fit in ceiling voids or spaces away from the unit, it stays out of sight and out of mind. A trusted all-rounder for standard HVAC applications, backed by a 2-year warranty. **If you're looking for the world's quietest mini pumps, try our Silent+ range, at only 16dB(A).**



20L/h max. flow



10m max. rec. head



19dB(A) @ 1m

Key Features

- Low maintenance
- Plug & play
- 2 year warranty

Suitability

- Up to 26kW / 90,000Btu/h
- Ducted units; floor standing & chassis units; high wall split systems
- **Perfect for...** small commercial and residential units

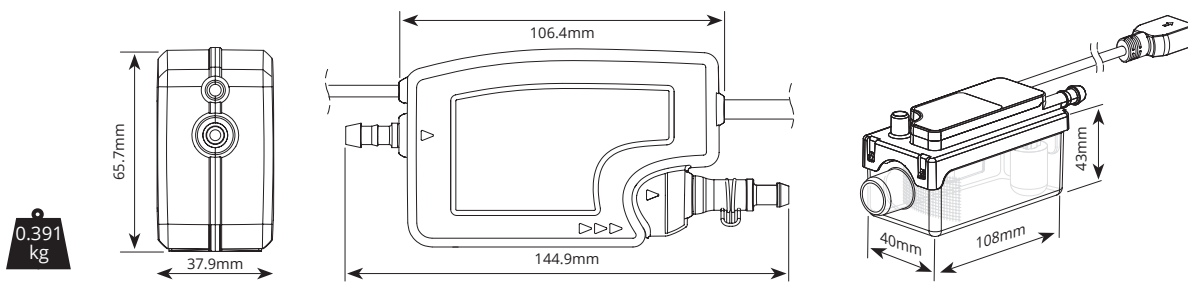

100V-250VAC @ 50Hz/60Hz	
Max. flow	20L/h @ 0m head
Max. rec. head	10m
Max. suction lift	1.5m
Min. dB(A) @ 1m	19dB(A)
Power supply	100-250VAC, 0.18A, 2.4W, 50/60 Hz
Rated	Continuous
Class	II □
Max. unit output	26kW (90,000Btu/h)
Max. ambient temp	40°C (104°F)
IP Protection	IP24
Inlet o/d	Ø16mm (5/8")
Outlet o/d	Ø6mm (1/4")
Safety switch	5.0 A Normally closed
Self priming	✓

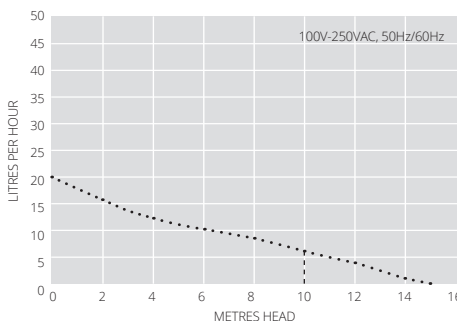

OPTIONS

Mini Orange FP3577

IN THE BOX

- Mini Orange pump • Reservoir (inc. filter and lid)
- Wall fixing pad • 1.5m Clear PVC tube
- 220mm inlet hose • 150mm Clear vent hose
- Drain connector kit: straight connector and rubber elbow • Quick Start Guide

SPARES		
Description		Part No.
Hose Clamp 10.1 dia. (x10)		B3340
S+ Mini Pump spare filters (x10)		FP3330
Barbed anti-siphon device		FP3336/1
Reservoir copper mesh filter (x10)		FP3460
Universal fixing bracket		FP3463
Mini Pump reservoir kit		FP3461

Download full manual at aspenspumps.com

Watch installation video at aspenspumps.com

Information correct at time of going to press. Not all products are available in all regions.

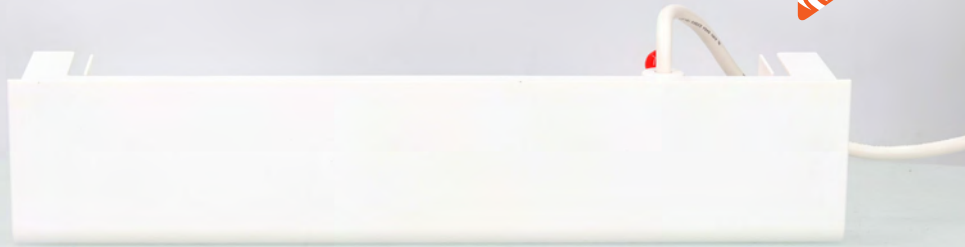

Mini Blanc™

CONDENSATE REMOVAL PUMP

The Mini Blanc is all about neat finishes and easy installs. Stylish and powerful, it mounts directly beneath wall units making it ideal for retrofit installations where aesthetics matter. Backed by Aspen reliability and a 2-year warranty, it's a clean choice for clean lines. **If you're looking for state-of-the-art of pump technology, upgrade to our Silent+ range.**



20L/h max. flow



10m max. rec. head
(flow rate 4L/h)



19dB(A) @ 1m

Key Features

- Fast install
- Easy maintenance access
- Removable reservoir
- Quiet operation
- Elegant and stylish casing
- 2 year warranty

Suitability

- Up to 26kW / 90,000Btu/h
- High wall split systems
- **Perfect for...** Domestic and commercial use – where easy maintenance is key

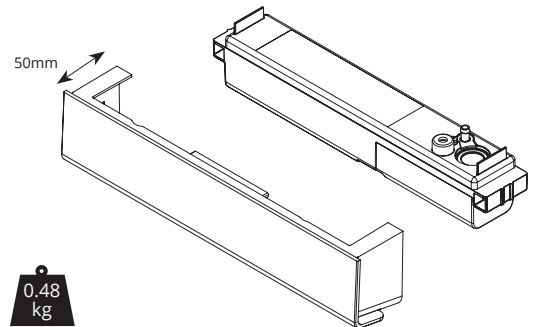
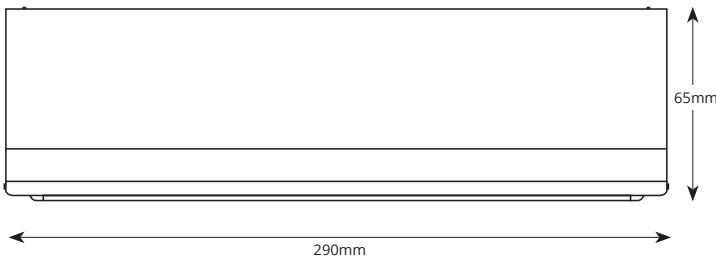

100V-250VAC @ 50Hz/60Hz

Max. flow	20L/h @ 0m head
Max. rec. head	10m
dB(A) @ 1m	19dB(A)
Power supply	230 VAC, 50.60Hz, 0.16A / 5W
Rated	Continuous
Class	II
Max. unit output	26kW (90,000Btu/h)
Max. water temp	40°C (104°F)
Inlet/outlet	20mm in 6mm out
IP Protection	IP24
Safety switch	5A Normally closed
Self priming	✓

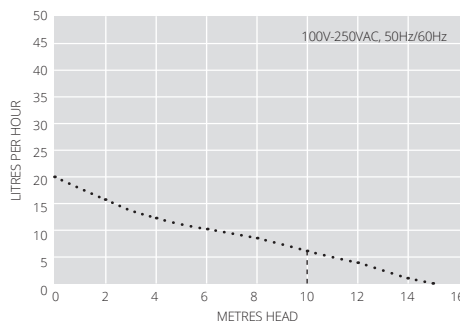

SUGGESTED ACCESSORIES

Description	Part No.
Mini Blanc 4.5 Foam Filter Spares (x10)	FP3587
Barbed anti-siphon device	FP3336/1
Reservoir copper mesh filter (x10)	FP3460

OPTIONS

Mini Blanc FP3578

IN THE BOX

Mini Blanc pump, Hard wired 1.5m power cable
• Fitting template (part of box) • Quick start guide

Download full manual at aspenspumps.com

Peristaltic pumps

Our peristaltic pump range is the 'best of the best'. Offering unrivalled remote install possibilities, they can be placed up to 3 metres from the AC unit without affecting performance. Perfect for spaces which require unobtrusive maintenance access (eg hotels, hospitals). Handling dirty water and with the added benefit that they can run dry, our peristaltic pump range is ideal for commercial remote applications.



Ultra Black Air



Ultra Black +



1 Remote access with minimal disturbance. Pump placed remotely from AC unit eg. above ceiling in hallway of hotel.

Information correct at time of going to press. Not all products are available in all regions.

01

CONDENSATE
REMOVAL PUMPS

PERISTALTIC



Ultra Black Air

CONDENSATE REMOVAL PUMP

The new Ultra Black Air offers outstanding reliability with an industry first 5 year warranty*. Built upon stepper motor technology and software control, this version offers user programmable speed control to minimise audible noise and tube wear.



15 L/h max. flow



12m max. head
(Flow rate 15 l/h)



21 dB(A) @ 1 m



1.12
kg

Key Features

- 5 year warranty*
- Configurable motor speed
- Flexible Installation with outstanding lift
- Easy to install with Patented mounting technology

Suitability

- Up to 20 kW (68 000Btu/h)
- High wall split systems; Ducted units; Floor standing & Chassis units
- **Perfect for...** hotel bedrooms and other remote install locations

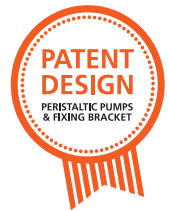
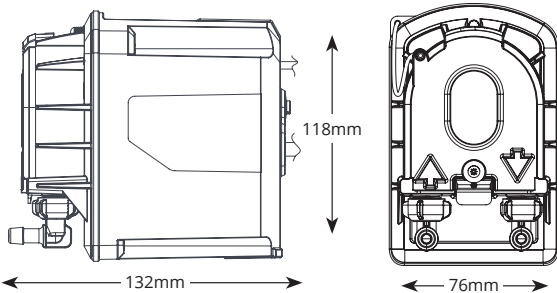

@ 230 VAC 50Hz	
Max. flow	15 L/h @ 12m head
Max. head	12m
Max. suction lift	3m
dB(A) @1m	21dB(A)
Power supply	110-230 VAC, 0.2A, 50/60Hz
Rated	Continuously
Class	II
Max. unit output	20kW (68 000 Btu/h)
Max. water output	40°C (104°F)
Inlet/Outlet	6mm ID
IP Protection	IP24
Safety Switch	5A NC relay
Self priming	✓

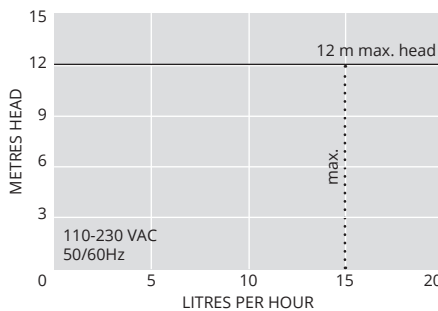

OPTIONS	
Ultra Black Air	FP3390

SUGGESTED ACCESSORIES	
Description	Part No.
Peri Spare Tube Kit	 FP3394
1 Amp Fuse	 FP2620
Tube Soil Stack Adaptor	 FP2038

IN THE BOX
Ultra Black Air Condensate Removal Pump • 3m Plug & Play Power/Sensor Cable • Wall Mounted Bracket • Fixing Kit • Installation Manual

Download manual at aspenspumps.com

Information correct at time of going to press. Not all products are available in all regions.



01

CONDENSATE
REMOVAL PUMPS

PERISTALTIC



Ultra Black +

FLOAT BASED CONDENSATE REMOVAL PUMP

The new Ultra Black + pump offers outstanding reliability with an industry first 5 year warranty*. Built upon stepper motor technology and software control, this version offers smart pumping technology similar to the latest mini pumps, always minimising audible noise and tube wear.



15L/h max. flow



12m max. head



21 dB(A) @ 1m



1.12
kg

Key Features

- 5 year warranty*
- Configurable motor speed
- Flexible Installation with outstanding lift
- Easy to install with Patented mounting technology

Suitability

- Up to 20 kW (68 000Btu/h)
- High wall split systems; Ducted units; Floor standing & Chassis units
- **Perfect for...** hotel bedrooms and other remote install locations

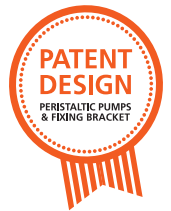
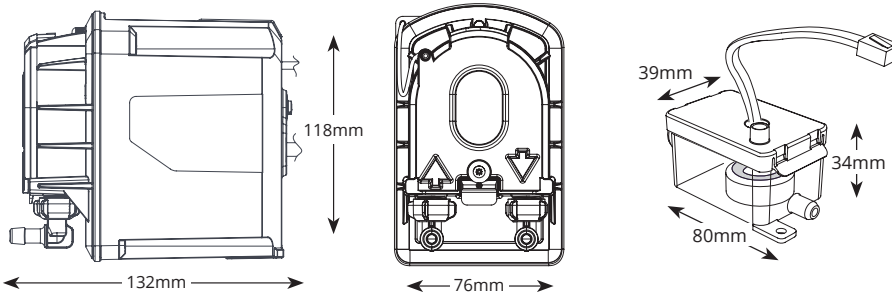

@ 230 VAC 50Hz	
Max. flow	15 L/h @ 12m head
Max. head	12m
Max. suction lift	3m
dB(A) @1m	21dB(A)
Power supply	110-230 VAC, 0.2A, 50/60Hz
Rated	Continuously
Class	II □
Max. unit output	20kW (68 000 Btu/h)
Max. water output	40°C (104°F)
Inlet/Outlet	6mm ID
IP Protection	IP24
Safety Switch	5A NC relay
Self priming	✓

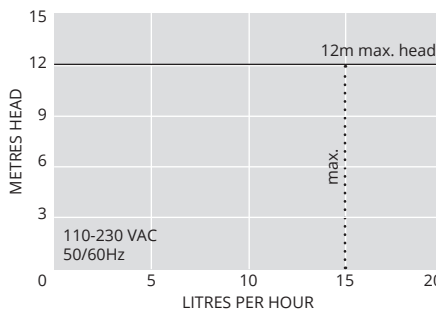

OPTIONS	
Ultra Black +	FP3391

SUGGESTED ACCESSORIES		
Description		Part No.
Peri Spare Tube Kit		FP3394
1 Amp Fuse		FP2620
Tube Soil Stack Adaptor		FP2038

IN THE BOX
Ultra Black + Condensate Removal Pump • 3m Plug & Play Power/Sensor Cable • Wall Mounted Bracket • Fixing Kit • Installation Manual

Download manual at aspenspumps.com

Information correct at time of going to press. Not all products are available in all regions.



Tank pumps

Our tank pump range is designed with you, the installer in mind. Easy to install and maintain, with features including easy clean tank, Plug & Play, twist & click non return valve and built in spirit level. When time is precious, Aspen tank pumps are installer friendly with unsurpassed performance as standard.



Mini Tank



Max Hi-Flow



Hi-Lift 1L & 2L



Heavy Duty 6 & 10



Hot Water Pumps

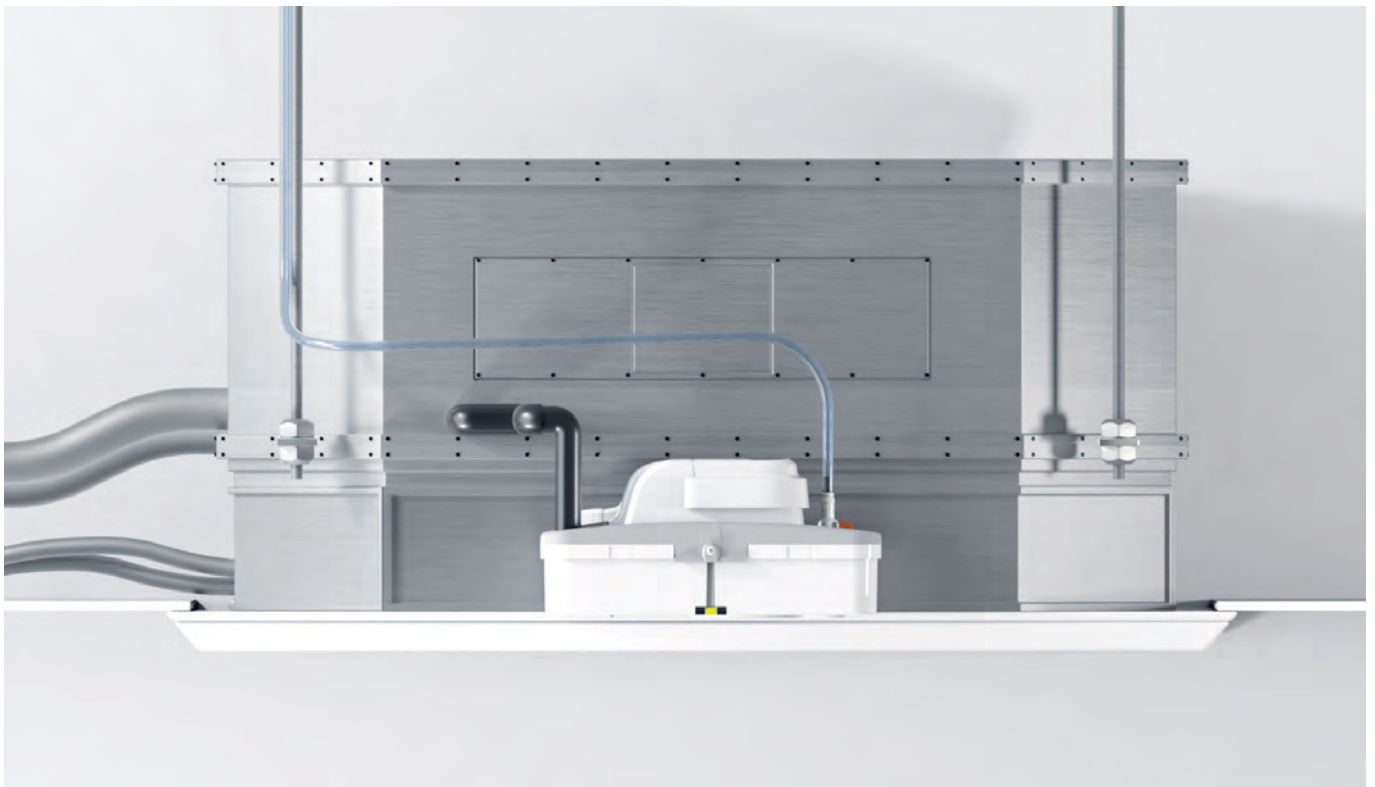

Max Hi-Flow screw mounted to cassette unit



Mini Tank

CONDENSATE REMOVAL PUMP

The new and improved Mini Tank pump can be wall mounted, floor mounted, in-pan or suspended on M8 / M10 rod. Using piston technology this is a compact, powerful and multi functional tank pump.



35L/h max. flow



15m max. rec. head
(flow rate 10L/h)

Key Features

- Four ways to install
- Compact & discreet
- Can be located in drain pan
- Easy maintenance

Suitability

- Up to 46kW (157,000 Btu/h)
- Ducted units; Cassette units
- **Perfect for...** Installation versatility

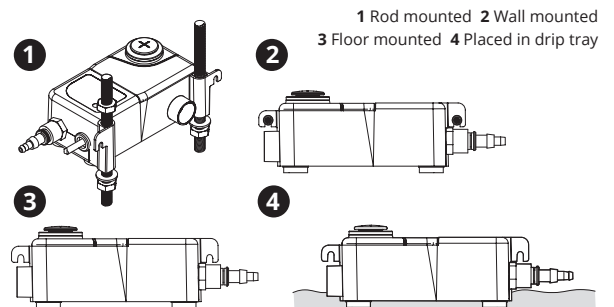
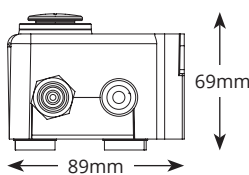
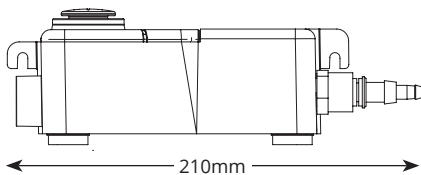

1 Rod mounted 2 Wall mounted
3 Floor mounted 4 Placed in drip tray

@ 230 VAC 50Hz	
Max. flow	35L/h @ 0m head
Max. rec. head	15m
Tank capacity	0.24L
dB(A) @ 1m	35dB(A)
Power supply	230 VAC, 50-60Hz, 0.1A
Rated	Non continuous
Class	II □
Max. unit output	46kW (157,000 Btu/h)
Max. water temp	40°C (104°F)
Inlets	x2 22mm, 12mm, 27mm
Outlets	6mm & 10mm
IP Protection	IP65
Safety switch	3.0A Normally closed
Thermal protection	✓
Fully potted	✓
Self priming	n/a

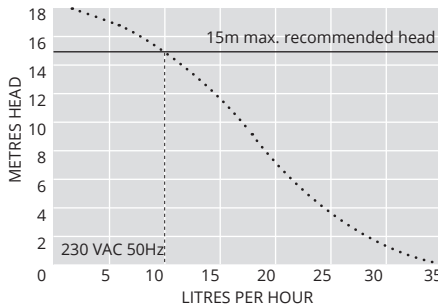

OPTIONS	
Mini Tank	FP1056/2

SUGGESTED ACCESSORIES		
Description		Part No.
Tank pump connector 16mm-21mm		FP2011
Tube To Soil Stack Adaptor		FP2038
Vinyl Tube Braided 1/4" (6mm)		AX5100

IN THE BOX	
Mini Tank pump (including hard wired 1m power cable) • x2 Rubber adaptors (21.5mm & 31mm) • Anti siphon device • Fixing kit • Install manual	

- 📖 Download manual at aspenspumps.com
- ▶ Watch installation video at aspenspumps.com

01

CONDENSATE
REMOVAL PUMPS

TANK

The lowest dB(A) & best IP rating (IP24) of any tank pump, the Max Hi-Flow is the quietest and best pump in its class.

Information correct at time of going to press. Not all products are available in all regions.





MAX Hi-Flow

CONDENSATE REMOVAL PUMP

The best in class Max Hi-Flow tank pump carries on the Aspen Pumps tradition of build quality & high performance. With the lowest dB(A) rating & best IP rating (IP24 splash proof) of any tank pump, the Max Hi-Flow is the quietest & best pump in its class.



550 L/h max. flow



5m max. rec. head
(flow rate 55L/h)

Key Features

- IP24 – Splash proof
- Easy access tank
- Built in spirit level
- Plug & Play

Suitability

- Up to 733kW (2.5m Btu/h)
- Ducted units; Floor standing & Chassis units; Cassette units
- **Perfect for...** Large commercial units

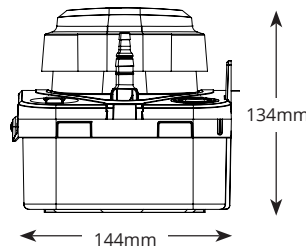
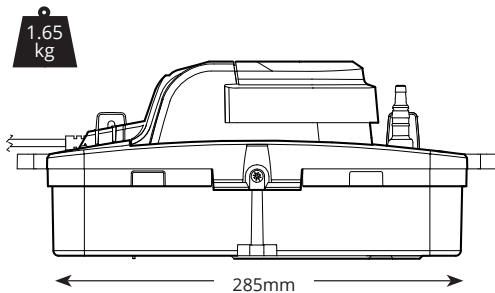

Non-return valve can be cut from 6mm to 10mm (see graphs below)

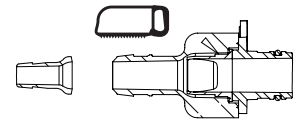

@ 230 VAC 50HZ

Max. flow	550L/h @ 0m head
Max. rec. head	5m
Tank capacity	1,7L
dB(A)@1m	44dB(A)
Power supply	230 VAC, 0.8A, 50Hz
Rated	Non Continuous
Class	I
Max. unit output	733kW (2.5m Btu/h)
Max. water temp	40°C (104°F)
Inlets	x4 21-27mm
Outlets	6mm & 10mm
IP Protection	IP24
Safety switch	3A Normally closed
Thermal protection	✓
Fully potted	n/a
Self priming	n/a

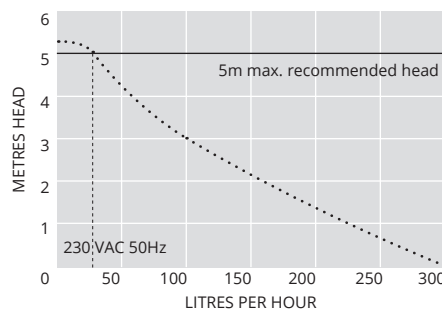
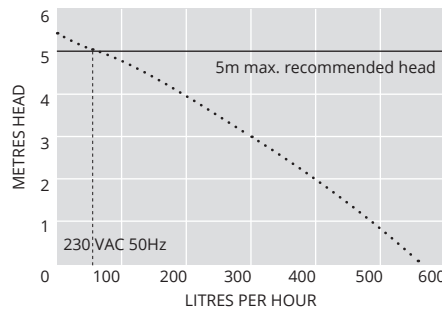

OPTIONS

Max Hi-Flow	FP3349
-------------	--------

SUGGESTED ACCESSORIES

Description	Part No.
Rubber adaptor	FP2013
Rigid pipe 15mm / 3/4"	B7501
Hose to waste	FP2038
Max Hi-Flow Insulation Sleeve	AX2500

IN THE BOX

Max Hi-Flow tank pump • Plug & Play power cable • Fixing kit incl. rod mount and wall mount clips • Install manual

Download manual at aspenspumps.com

Watch installation video at aspenspumps.com

Information correct at time of going to press. Not all products are available in all regions.

01

CONDENSATE
REMOVAL PUMPS

TANK



Hi-Lift 1L & 2L

CONDENSATE REMOVAL PUMP

The world's only persaltic tank pump offers unsurpassed high head and unmatched reliability.



11L/h max. flow



12m max. head
(flow rate 11L/h)

Key Features

- High head
- Easy fit & maintenance
- Easy access clean tray
- Built in spirit level

Suitability

- Up to 14kW (47,000 Btu/h)
- Ducted units; Floor standing & Chassis units; Cassette units; Refrigerated units/cold store
- **Perfect for...** High head applications

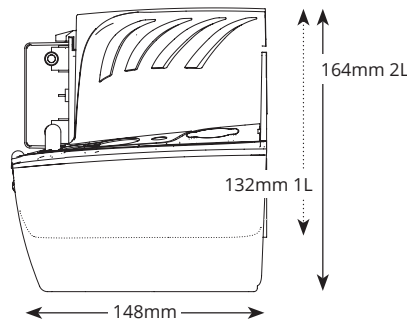
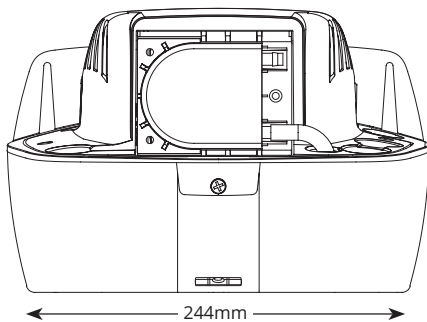

@ 230 VAC 50Hz	
Max. flow	11L/h @ 0m head
Max. head.	12m
Tank capacity	1L & 2L
dB(A) @1m	51dB(A)
Power supply	230 VAC, 50-60Hz, 0.4A
Rated	Continuously
Class	I
Max. unit output	14kW (47,000 Btu/h)
Max. water output	40°C (104°F)
Inlet/Outlet	3x 25mm in, 6mm out
IP Protection	IP20
Safety Switch	3.0A Normally closed
Thermal protection	✓
Fully potted	n/a
Self priming	n/a

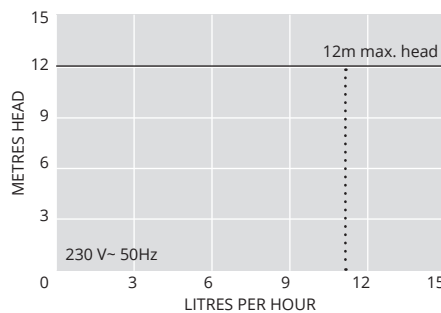

OPTIONS	
Hi-Lift 1L	FP2099/2
Hi-Lift 2L	FP2071/2

SUGGESTED ACCESSORIES		
Description		Part No.
Tank pump connector 16mm-21mm		FP2011
Tube To Soil Stack Adaptor		FP2038
Vinyl Tube Braided 1/4" (6mm)		AX5110

IN THE BOX
Hi-lift 1L or 2L pump • 2m Plug & Play power cable • Fixing kit • Install manual

Download manual at aspenspumps.com

Information correct at time of going to press. Not all products are available in all regions.





Heavy Duty 6 & 10

CONDENSATE REMOVAL PUMP

The Heavy Duty condensate removal pump is designed for high-demand HVAC systems, handling large condensate loads with quiet, reliable operation. Built to withstand the toughest commercial and industrial environments. These pumps are easy to install and combines power, reliability and durability.



HD6: Max. flow 900 l/h
HD10: Max. flow 1070 l/h



HD6: 6m max. rec. head
(flow rate 180L/h)
HD10: 9m max. rec. head
(flow rate 100L/h)



5.2
kg

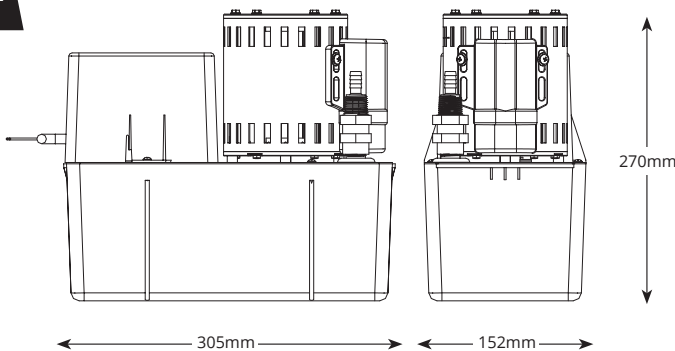

Key Features

- High flow rate
- Non return valve
- Easy installation
- 4 litre tank capacity
- High level safety switch

Suitability

- HD6: Up to 1200 kW (4m Btu/h)
HD10: Up to 1460 kW (4.9m Btu/h)
- Dehumidifiers; Air handling units (AHUs)
- **Perfect for...** Large volumes of water

HEAVY DUTY 6 & 10 @ 230 VAC 50Hz	
Max. flow	HD6: 900 L/h, HD10: 1070 L/h
Max. rec. head	HD6: 6m, HD10: 9 m
Tank capacity	4L
Sound level@1m	HD6: 64dB(A), HD10: 64dB(A)
Power supply	HD6: 230 VAC, 50Hz, 1.1A HD10: 230 VAC, 50Hz, 1.1A
Rated	HD6: Continuous HD10: Continuous
Class	I Appliance
Max. unit output	HD6: 1200kW (4m Btu/h) HD10: 1460kW (4.9m Btu/h)
Max. ambient temp	40°C (104°F)
Max. water temp	40°C (104°F)
Inlet/Outlet	40mm in, 10mm out
IP Protection	IP20
Safety Switch	5.0A Normally closed

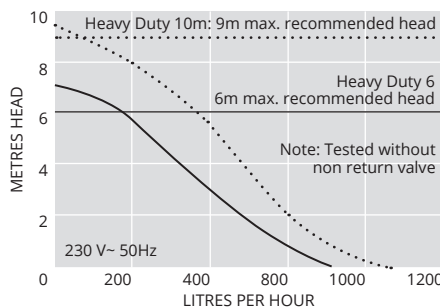

OPTIONS	
Heavy Duty 6	FP2074/3
Heavy Duty 10	FP2066/3

SUGGESTED ACCESSORIES	
Description	Part No.
Rubber Adaptors 3/4" (19mm) - 1 1/2" (38mm)	FP2007
Tube to Soil Stack Adaptor	FP2038
Vinyl Tube Braided 3/8" (10 mm)	AX5101

IN THE BOX
Heavy Duty 6 or 10 pump • Hard wired 2m power cable • Install manual

Download manual at aspenspumps.com



Hot Water Economy

CONDENSATE REMOVAL PUMP

The Hot Water Economy pump ensures efficient, quiet operation at high temperatures, handling demanding applications with ease. Built to withstand water temperatures up to 100°C, it's ideal for industrial and commercial air handling units.



900L/h max. flow



6m max. rec. head
(flow rate 280L/h)



5.2
kg

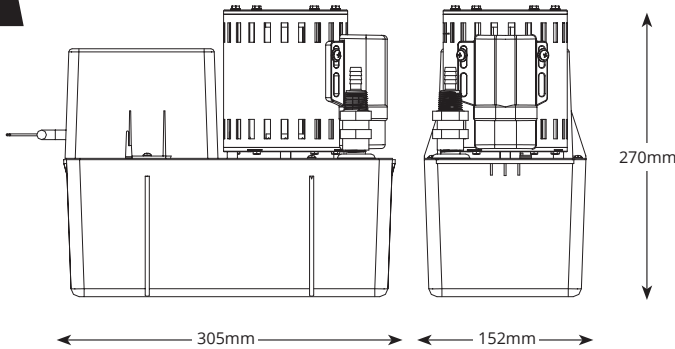

Key Features

- High performance
- Handles 100°C water
- High level safety switch
- 40mm inlet

Suitability

- Up to 1200kW / 4m Btu/h
- Humidifiers; refrigeration; air handling units (AHUs)
- **Perfect for...** Humidifiers

HOT WATER ECONOMY @ 230 VAC 50Hz

Max. flow	900L/h
Max. rec. head	6m
Tank capacity	4L
Sound level@1m	64dB(A)
Power supply	230 VAC 50Hz 1.1A
Rated	Continuous
Class	I appliance
Max. ambient temp	40°C / 104°F
Max. water temp	100°C / 212°F
Inlet/outlet	40mm in, 10mm out
IP Protection	IP20
Safety switch	5.0A Normally closed

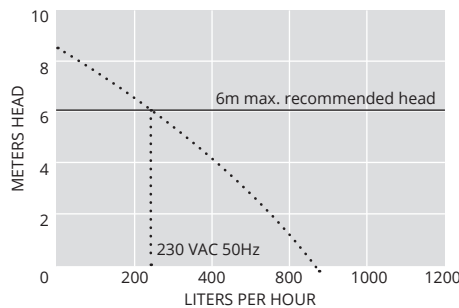

SUGGESTED ACCESSORIES

Description	Part No.
Rubber Adaptor 3/4" (19mm) – 1 1/2" (38mm)	FP2007
Tube To Soil Stack Adaptor	FP2038
Vinyl Tube Braided 3/8" (10mm)	AX5111

HOT WATER ECONOMY OPTIONS

Hot Water Economy FP2092/3

IN THE BOX

Hot Water Economy Pump • Hard wired 2m power cable • Install manual

Download manual at aspenspumps.com

Information correct at time of going to press. Not all products are available in all regions.

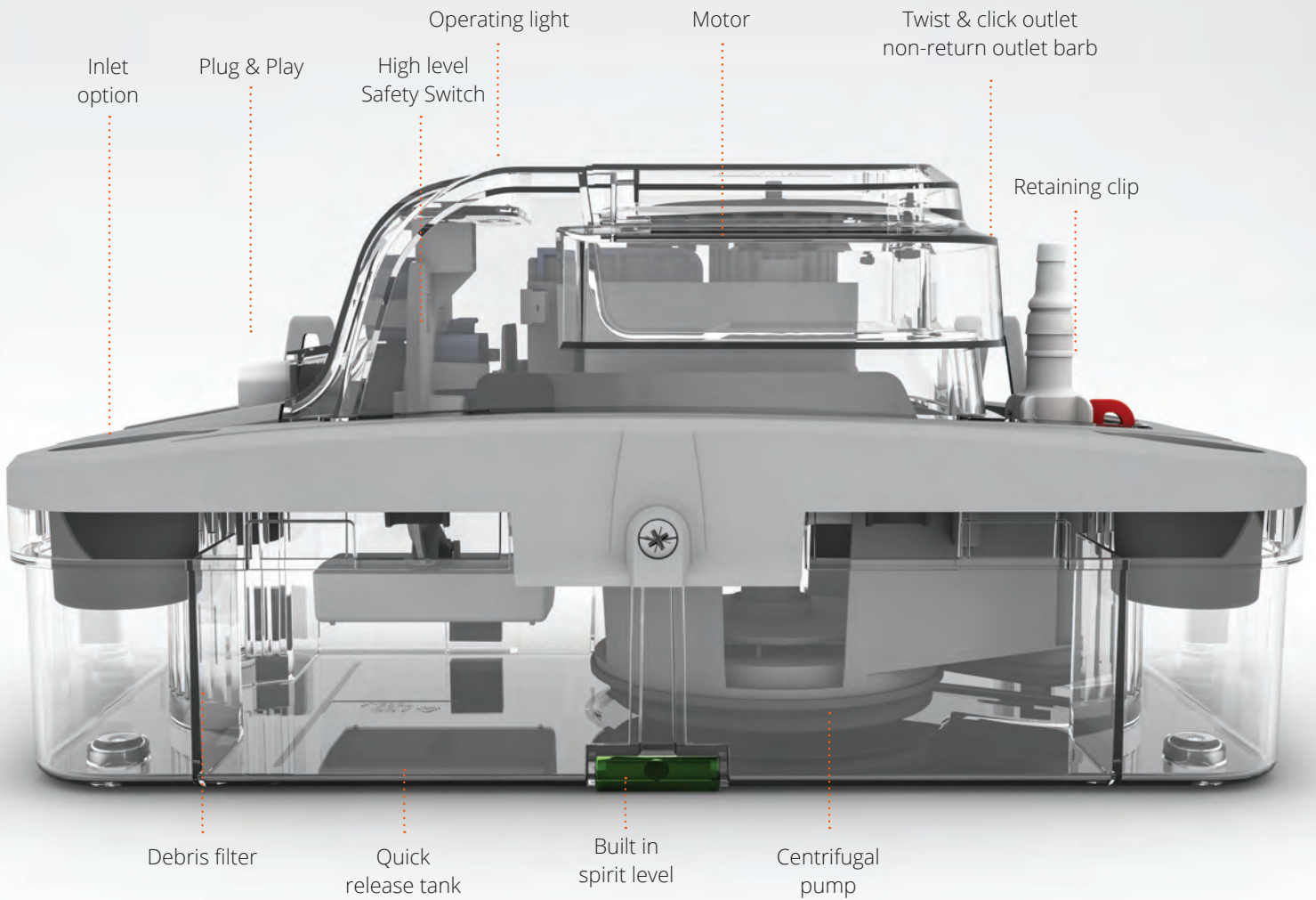

THE PROFESSIONAL WAY

So why should you choose a condensate pump? Traditionally, removing condensate water from an air conditioning unit is an inflexible and often unattractive challenge.

Installation

We understand that flexibility is key when considering your installation. Gravity drainage can often bring limitations on placement of the unit – indoor or outdoor. Condensate removal pumps allow optimum positioning and aesthetics in any installation, without losing out on efficiency or performance. Aspen Pumps give ultimate installation flexibility whatever the application.



The only option

Sometimes gravity drainage just isn't an option. Removal of condensate water in spaces such as basements, shallow ceiling voids and glass buildings never need to be a problem again. Maintenance is easy, and with a wide range of pumps to choose from, service, relocation or replacement is stress-free. As engineers, we understand that your time is precious, so we take the time to get it right for you.



A professional install

Condensate removal pumps ensure a professional, aesthetically pleasing installation every time. With easy access for maintenance, a pump ensures that air conditioning units are placed where requested with no unsightly pipework. The condensate water can be effectively managed to the relevant source such as a soil stack or grey water tank, ensuring a professional finish everytime.



Information correct at time of going to press. Not all products are available in all regions.

Supermarket Pumps

Designed for retail chiller cabinets, this range of pumps is extremely easy to install and maintain. Placed directly below the refrigeration unit they remove water during the defrost cycle. The Hi Capacity 11L, Compact 4L ERRP & Low Profile Cold Cabinet both feature a unique debris filter, whilst the Macerator features a filter blade to stop the pumps from clogging with food debris.



Hi Capacity 11L
ERRP



Compact 4L
ERRP

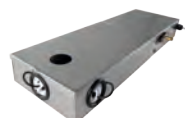

Low Profile
Cold Cabinet



Macerator 4L



All our refrigeration pumps simply fit beneath the refrigeration unit

Information correct at time of going to press. Not all products are available in all regions.

01

CONDENSATE
REMOVAL PUMPS

SUPERMARKET



Modbus: FP3555



High Capacity 11L ERRP

CONDENSATE REMOVAL PUMP

Our High Capacity 11L Economy Retail Refrigeration Pump has a large tank size, yet with same low profile as our Compact 4L – just 75mm! Meeting today's demands of modern refrigeration units. Effectively pumping away defrost and contaminated water.



230 L/h max. flow



35m max. head

Key Features

- Only 75mm height
- 2 stage filter to catch debris and prevent spread and growth of biofilm
- Low voltage at point of use
- Plug & Play

Suitability

- Refrigeration units; cold store cabinets
- **Perfect for...**
Multiple refrigeration units

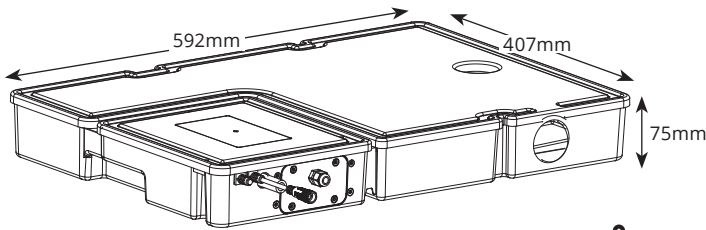

3.91
kg



@ 230 VAC 50Hz	
Max. flow	230 L/h @ 0 head
Max. rec. head	35m
Tank capacity	11.1L
Sound level @ 1m	60 dB(A)
Power supply Input:	100-240V AC 50/60Hz
Rated	Non continuous
Class	II appliance <input type="checkbox"/>
Max. ambient temp.	40°C / 104°F
Inlet/Outlet	40mm in, 10mm out
IP Protection	IPX4
Safety Switch	3A NC/NO
Thermal protection	✓
Flammable refrigerant compatibility	Designed to minimise spark risk
Equipment communication	Modbus RTU (option extra: FP3555)

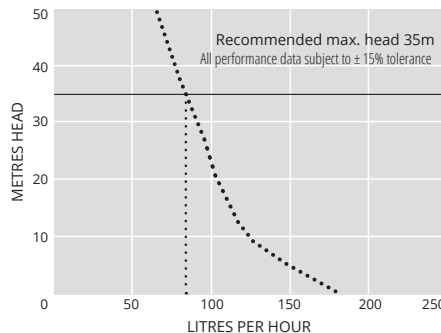

SUGGESTED ACCESSORIES		
Description		Part No.
Vinyl Tube Braided 3/8" (10 mm)		AX5101
Jallystrips		S010371

OPTIONS	
Side inlet	FP3552
Top inlet	FP3553
Download manual at aspenspumps.com	

IN THE BOX
ERRP pump • 2m Plug & Play power cable • 11/2" BSP connector (for 40mm ID waste pipe) • Install manual

Information correct at time of going to press. Not all products are available in all regions.



01

CONDENSATE
REMOVAL PUMPS

SUPERMARKET



Modbus: FP3555



Compact 4L ERRP

CONDENSATE REMOVAL PUMP

Our Compact 4L Economy Retail Refrigeration Pump is designed exclusively to fit underneath retail refrigeration cabinets allowing for the removal of defrost and contaminated water.



190L/h max. flow



35m max. head

Key Features

- Lightweight & slim
- Low voltage at point of use
- 2-stage filter to prevent growth and spread of biofilm
- Plug & Play

Suitability

- Refrigeration units; cold store cabinets
- **Perfect for...** Single & multiple refrigeration units

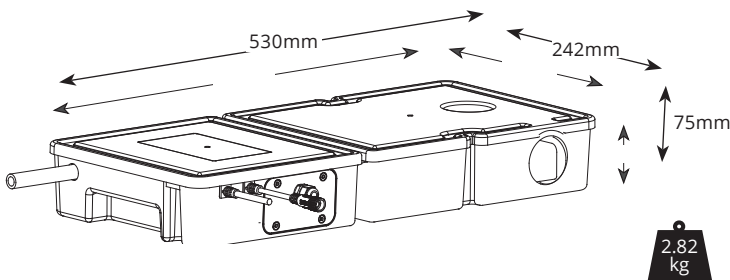

@ 230 VAC 50Hz	
Max. flow	190 L/h @ 0 head
Max. rec. head	35m
Tank capacity	4.2L
Sound level @ 1m	60 dB(A)
Power supply Input:	100~240V AC 50/60Hz
Rated	Non continuous
Class	II appliance <input type="checkbox"/>
Max. ambient temp.	40°C / 104°F
Inlet/Outlet	40mm in, 10mm out
IP Protection	IPX4
Safety Switch	3A NC/NO
Thermal protection	✓
Flammable refrigerant compatibility	Designed to minimise spark risk
Equipment communication	Modbus RTU (option extra: FP3555)

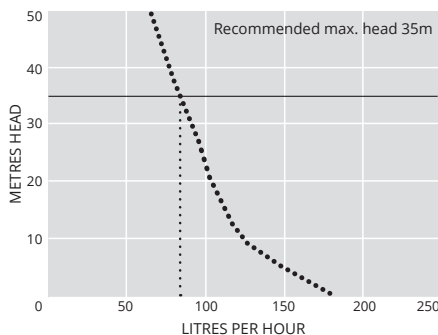

OPTIONS

Side inlet	FP3550
Top inlet	FP3551

Download manual at aspenspumps.com

SUGGESTED ACCESSORIES

Description	Part No.
Vinyl Tube Braided 3/8" (10 mm)	AX5101
Jallystrips	S010371

IN THE BOX

Low Profile ERRP pump • 2m Plug & Play power cable • 11/2" BSP connector (for 40mm ID waste pipe) • Install manual

Information correct at time of going to press. Not all products are available in all regions.





Low Profile Cold Cabinet

CONDENSATE REMOVAL PUMP

Made from robust stainless steel, this pump is extremely easy to install and maintain. With a feature designed to keep waterways moving, reducing the opportunity for biofilm to settle, the pump is placed directly below retail refrigeration cabinets removing condensate during the defrost cycle.



700L/h max. flow



20m max. head
(Flow rate 10 L/h)

Key Features

- Integrated jet flow dispersal system to reduce biofilm build up
- Robust, abrasion resistant stainless steel casing
- Multiple inlets for flexible installation (top, end & both sides)
- Removable barbed brass outlet connector for ease of maintenance

Suitability

- Shallow 75mm height, lower than traditional dairy units
- Single and multiple refrigeration units, OEM
- **Perfect for...** multiple refrigeration units with shallow access

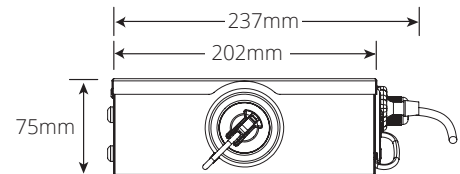
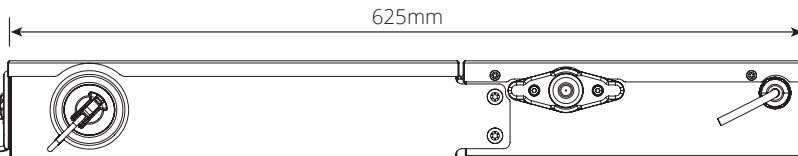

@ 230 VAC 50Hz	
Max. flow	700L/h @ 0m head
Max. head	20m (Max. rec. 18m)
Tank capacity	4.6L
dB(A) @1m	60
Power supply	230 VAC, 0.6A, 50/60Hz
Rated	Non continuous
Class	I
Max. unit output	1.59m Btu/h – 460kW
Max. water output	40°C / 104°F
Inlet/Outlet	4x ø48mm holes with plugs with 3x inlet plugs assemblies
IP Protection	IP44
Safety Switch	1A Normally closed
Thermal protection	✓
Fully potted	n/a
Self priming	n/a

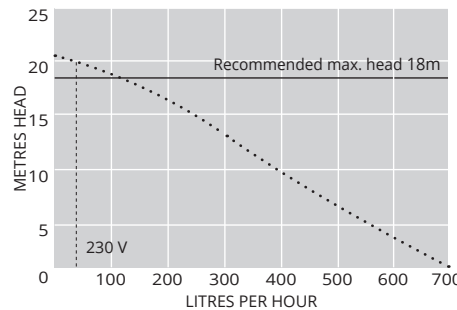

SUGGESTED ACCESSORIES		
Description		Part No.
1 Amp Fuse		FP2620
Tube to Soil Stack Adaptor		FP2038
Vinyl Tube Braided 3/8" (10 mm)		AX5101

OPTIONS	
LP Cold Cabinet – top, end and both side inlets	FP3560

IN THE BOX
• Low Profile Cold Cabinet pump • 3 x inlet plug assemblies • 1 x inline Non-return valve (NRV) • 1 x 1 1/2" waste connector for 40mm waste pipe • 1 x 3/8"-1/2" outlet pipe adaptor • Install manual

Download manual at aspenspumps.com

Information correct at time of going to press. Not all products are available in all regions.



Macerator 4L

CONDENSATE REMOVAL PUMP

The Macerator pump efficiently handles condensate and defrost water from multiple refrigeration units, and will deliver reliable, quiet performance in high-demand commercial environments.



780L/h max. flow



8.5m max. rec. head
(flow rate 80L/h)



5.2
kg

Key Features

- Internal filter blade
- High flow & head
- High level safety switch

Suitability

- Single and multiple refrigeration units
- **Perfect for...** handling food waste that may pass through the pump

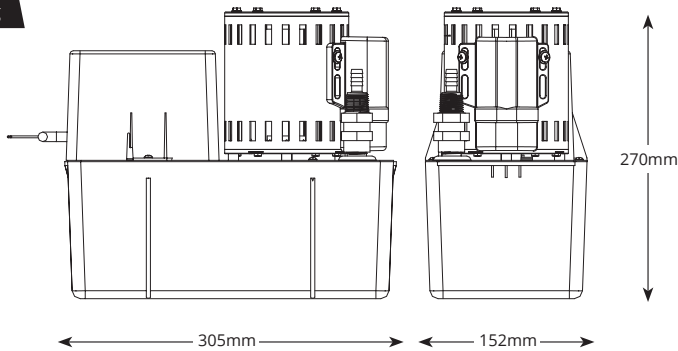

MACERATOR 4L @ 230 VAC 50-60HZ	
Max. flow	780L/h
Max. rec. head	8.5m
Tank capacity	4L
Sound level@1m	64dB(A)
Power supply	230VAC, 50Hz, 1.1A
Rated	Continuous
Class	I appliance
Max. ambient temp	40°C/104°F
Max. water temp	40°C/104°F
Inlet/outlet	40mm in, 10mm out
IP Protection	IP20
Safety switch	5.0A Normally closed

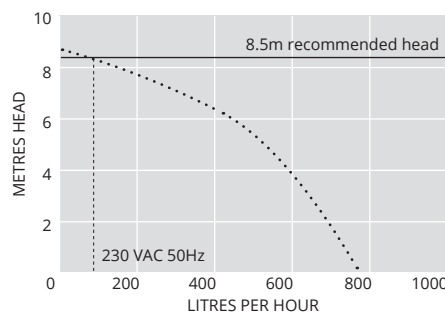

SUGGESTED ACCESSORIES	
Description	Part No.
Vinyl Tube Braided 3/8" (10mm)	AX5101

MACERATOR 4L OPTIONS	
Macerator 4L	FP2305/3

IN THE BOX
Macerator 4L pump • Hard wired 2m power cable • Install manual

Download manual at aspenspumps.com

Boiler Pumps

A condensing boiler is a high efficiency boiler that recycles and takes heat from the exhaust gases leaving excess water. Our high performance boiler pumps remove this excess water offering excellent performance, easy inspection and great aesthetics.



Endurance



Kitchen



- 1 Kitchen boiler pump wall mounted beneath boiler.
- 2 Hi-Capacity boiler pump floor mounted next to floor standing boiler.

Information correct at time of going to press. Not all products are available in all regions.



Endurance

BOILER CONDENSATE REMOVAL PUMP

The Aspen Endurance has been ruggedised to maximise reliability in boiler applications. Its construction allows short infrequent temperature excursions to 85°C. It can handle pH > 2.2 for applications where a neutraliser is not required.



550 L/h Max. flow



5m max. head
(flow rate 55L/h)

Key Features

- Stainless steel motor shaft
- Max. working temperature 60°C with short infrequent excursions to 85°C (<5 min)
- Thermally protected maintenance free motor
- IP24 protection against water splashes

Suitability

- Up to 200 kW / 682,000 Btu/h
- Suitable for acidic condensate with pH >2.2 and <2.2 with neutraliser
- Spirit level for ease of install
- **Perfect for...** Larger domestic & commercial condensing boilers

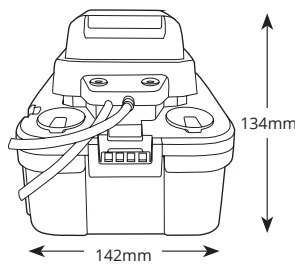
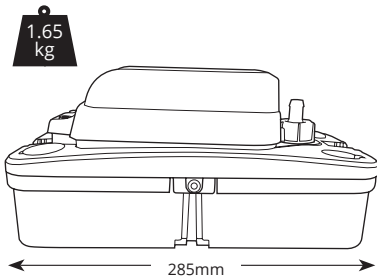

Non-return valve can be cut from 6mm to 10mm (see graphs below)

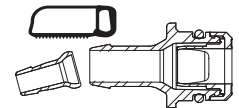

@ 230 VAC 50Hz	
Max. flow	550 L/h @ 0m head
Max. rec. head	5m
Tank capacity	1.5L
dB(A) @1m	44 dB(A)
Power supply	230 VAC, 50/60Hz, 0.8A
Rated	Non continuous
Class	I
Max. unit output	200kW (682,000 Btu/h)
Max. water output	60°C (140°F)
Inlet/Outlet	x4 21-27mm in 6 & 10mm out
IP Protection	IP24
Safety Switch	3.0A Normally closed
Thermal protection	✓

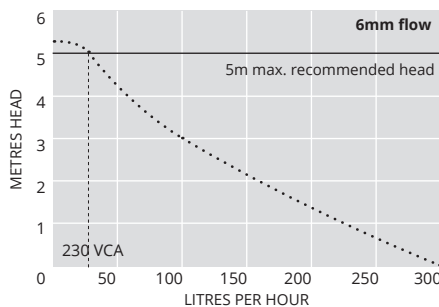
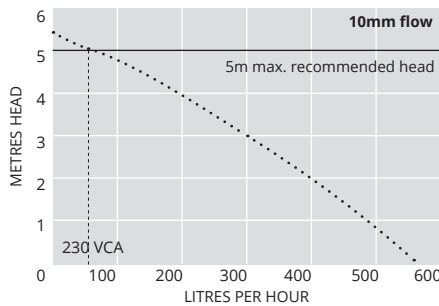

OPTIONS

Endurance (EU)	FP3500
Endurance (UK)	FP3501

SUGGESTED ACCESSORIES

Description	Part No.
Tube Soil Stack Adaptor	FP2038
1 Amp Fuse	FP2620
Vinyl Tube Braided 1/4" (6mm)	AX5100
Vinyl Tube Braided 3/8" (10mm)	AX5101

IN THE BOX

- Endurance pump
- Outlet Adapter
- Clear PVC hose (6m of 10mm)

Download manual at aspenspumps.com



Kitchen

BOILER CONDENSATE REMOVAL PUMP

Designed to take the heat! Extra quick & easy to fit, the Kitchen all-in-one boiler pump is designed to be fitted beneath domestic gas boilers and furnaces.



12 L/h max. flow



10m max. head
(flow rate 4 L/h)



21dB(A)

Key Features

- Compact & discreet
- Mounts under boiler
- Quiet operation
- Clear removable reservoir

Suitability

- Up to 45kW / 153,000 Btu/h with condensate pH value >2.7
- **Perfect for...** Domestic gas fired condensing boilers & furnaces

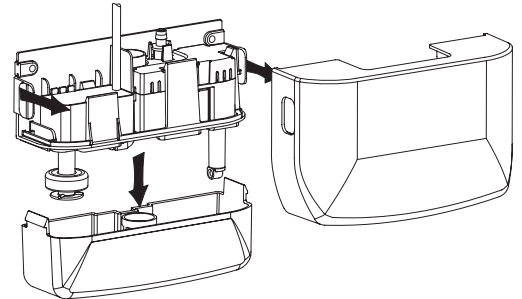
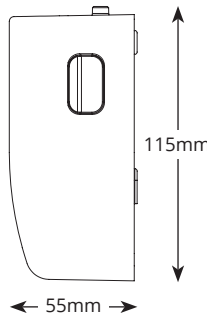
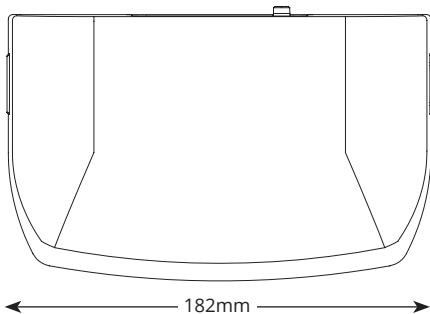

@ 230 VAC 50Hz	
Max. flow	12L/h @ 0m head
Max. rec. head	10m
Tank capacity	0.24L
dB(A) @1m	21dB(A)
Power supply	230 VAC, 50-60Hz, 0.1A
Rated	Non continuous
Class	II
Max. unit output	45kW (153,000 Btu/h)
Max. water output	60°C (140°F)
Inlet/Outlet	20mm in, 6 mm out
IP Protection	IP21
Safety Switch	3.0A Normally closed
Thermal protection	✓
Fully potted	✓
Self priming	n/a

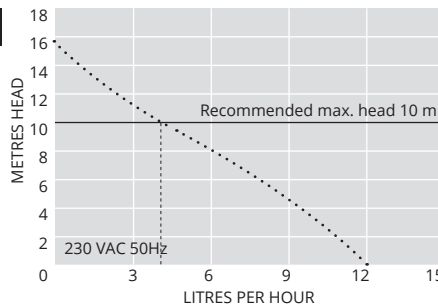

OPTIONS
Kitchen FP2943

SUGGESTED ACCESSORIES		
Description		Part No.
Tube Soil Stack Adaptor		FP2038
1 Amp Fuse		FP2620
Vinyl Tube Braided 3/8" (10 mm)		AX5100
Acid Neutraliser		FP1021

IN THE BOX
Kitchen boiler pump (inc. 1m power cable)
• 6m discharge tube (6mm ID) • Inlet adaptor for 22 & 28mm pipe • Pipe adaptor • Fixing kit
• Install manual

Download manual at aspenspumps.com

Information correct at time of going to press. Not all products are available in all regions.



Silent+ Mini Pumps

16
dB(A)

The World's Quietest
Mini Pump

Up to
46
kW

One Size
Fits All

3
year
warranty

No
Maintenance

“Definitely ‘quietly brilliant’ 🤫”

“ The new Mini Limes are very very quiet!!!
Had to pop the cover off to see if it was running!”

“ Very impressed at how quiet they are.”



INSTALLATION VIDEOS



Silent+ Mini White
FP3450

Silent+ Mini Aqua
FP3420



Silent+ Mini Orange
FP3430



Silent+ Mini Lime
FP3322/5 (Pump only)



aspenpumps.com | +44 (0)1323 848842 | sales@aspenpumps.com

16dB(A) assuming solid wall construction with a 2kW unit



02

Hand Tools	38-51
Cutters	52-54
Lifters	55-56

SERVICE & TOOLING



Left to right: JAV-1010, JAV-1015, JAV-1013, JAV-1012, JAV-1014 Cuts stainless steel up to 3mm thick. Heavy duty with 6 ball bearing rollers JAV-1011 Ratchet tube cutter set (includes JAV-1010 tube cutter), JAV-1009



Smart spring design



JAV-1011: 2-in-1 design

Tube Cutters



All our JAVAC Edge tube cutters feature:

- Titanium plated blade
- Patented Smart Spring Design
- Automatic Cutting. The spring pressure advances the blade when cutting, so there is no need to re-tighten the cutter

Size	Tube Cutter	Replacement blades (packs of 2)
1/8 – 5/8"	JAV-1009	JAV-1008
1/8 – 7/8"	JAV-1010	
1/8 – 7/8"	JAV-1011	JAV-1001
1/8 – 1-1/4"	JAV-1012	
1/8 – 1-5/8"	JAV-1013	JAV-1005
1/4 – 1-1/4"	JAV-1014	JAV-1006
3/8 – 2-5/8"	JAV-1015	JAV-1003



Replacement blades

Information correct at time of going to press. Not all products are available in all regions.



Tube positioning plate

Eccentric Flaring Tool



Avoid leaks, make the perfect flare the easiest way with the Tube Positioning Plate – the plate ensures the tube is set at the correct position

- Hard plastic carry case

Set options	Part No.
7 Sizes: 3/16" 1/4", 5/16", 3/8", 1/2", 5/8", 3/4"	JAV-1024
7 Sizes: 6, 8, 10, 12, 15, 16, 18mm	JAV-1185

Flare Size Gauge

Designed to measure all flares to offer 100% seal tightness against all flare fittings, a must for every toolbox.

Description	Part No.
Flare Size Gauge	JAV-1022



Information correct at time of going to press. Not all products are available in all regions.



2-in-1 Flaring & Swaging Tool



An easy to use 2-in-1 one design that can be used to flare or swage. Perfect flaring and swaging, less to carry with extra room in the van for more tools!

- Diamond Flaring Cone deburrs and polishes during the flaring process creating an exceptional finished surface, meaning less time deburring
- Patented Diamond Flaring Cone has a unique 'square edge fitting' so when attached the cone is allowed to spin as you turn the handle. Creating a perfectly smooth finish
- Indexing Mechanism Provides accurate alignment when switching between different hole positions on the flaring bar.
- Tube Positioning Plate ensures the tube is set at the correct position for all sizes
- Hard plastic carry case
- Hard drawn copper must be heated prior to use

Set options	Part No.
6 Sizes: 1/4", 5/16", 3/8", 1/2", 5/8", 3/4"	JAV-1023
7 Sizes: 6, 8, 10, 12, 15, 16, 18mm	JAV-1184

Information correct at time of going to press. Not all products are available in all regions.



Tube positioning plate

Dual Clutch Eccentric Flaring Tool



Dual clutch design. Clutch releases when the flare is complete to prevent over compression

- Drill powered or manual
- Lightweight aluminium body and superior steel core
- Hard plastic carry case

Description	Part No.
7 sizes: 3/16" 1/4", 5/16", 3/8", 1/2", 5/8", 3/4"	JAV-1034
7 Sizes: 6, 8, 10, 12, 15, 16, 18mm	JAV-1186

Information correct at time of going to press. Not all products are available in all regions.

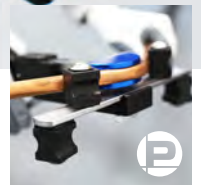
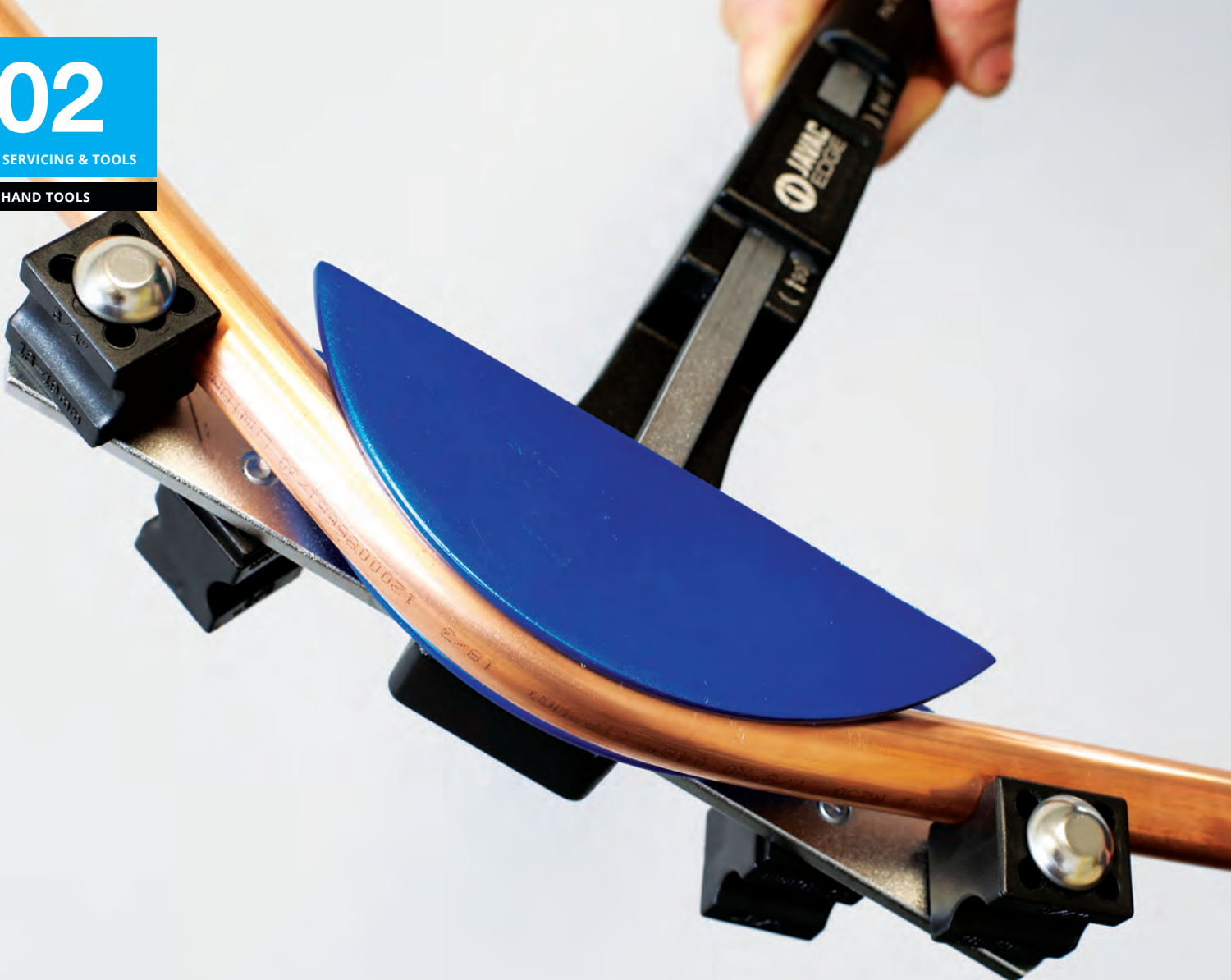

90° Indicator

Reverse bending adaptor

Tube Bender Set

MULTI SIZE



- Patented 90° Indicator feature so you know when the tube has accurately reached a perfect 90° bend
- Complete with Reversing Adaptors to bend pipe in all directions with ease - perfect for awkward spaces
- 7 x mandrel sizes; 1 x Reverse bending attachment
- Hard plastic carry case
- For use on soft drawn copper only

Set options	Part No.
7 Sizes: 1/4", 5/16", 3/8", 1/2", 5/8", 3/4", 7/8"	JAV-1021
7 Sizes: 6, 8, 10, 12, 15, 18, 22mm	JAV-1183

Spares			
Counterformer	Part No.	Mandrel	Part No.
1/4 - 3/8"	JAV-9001	1/4"	JAV-1143
1/2 - 7/8"	JAV-9002	5/16"	JAV-1144
		3/8"	JAV-1145
		1/2"	JAV-1146
		5/8"	JAV-1147
		3/4"	JAV-1148
		7/8"	JAV-1149
		16 mm	JAV-1044

Information correct at time of going to press. Not all products are available in all regions.



JAV-1025



1/4" / 6mm Expander Head*

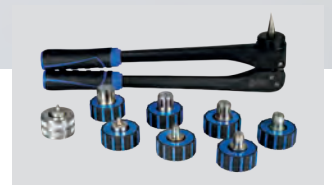

Tube Expander Set

MULTI SIZE



- Patented 1/4" / 6mm Expander Head makes small to large pipework joining installations a breeze
- Hard plastic carry case
- Hard drawn copper must be heated/annealed

Expander Heads Only

Set options	Part No.
8 Sizes: 1/4", 3/8", 1/2", 5/8", 3/4", 7/8", 1", 1-1/8"	JAV-1025
8 Sizes: 6, 8, 10, 12, 15, 16, 18, 22mm	JAV-1187

Sizes	Part No.	Sizes	Part No.
1/4"	JAV-1081	6mm	JAV-1188
1/2"	JAV-1080	8mm	JAV-1189
3/4"	JAV-1082	10mm	JAV-1190
3/8"	JAV-1083	12mm	JAV-1191
5/8"	JAV-1084	15mm	JAV-1192
7/8"	JAV-1085	16mm	JAV-1193
1"	JAV-1088	18mm	JAV-1194
1-1/8"	JAV-1086	22mm	JAV-1195
1-3/8"	JAV-1054	25mm	JAV-1196
1-5/8"	JAV-1055	28mm	JAV-1197

Information correct at time of going to press. Not all products are available in all regions.

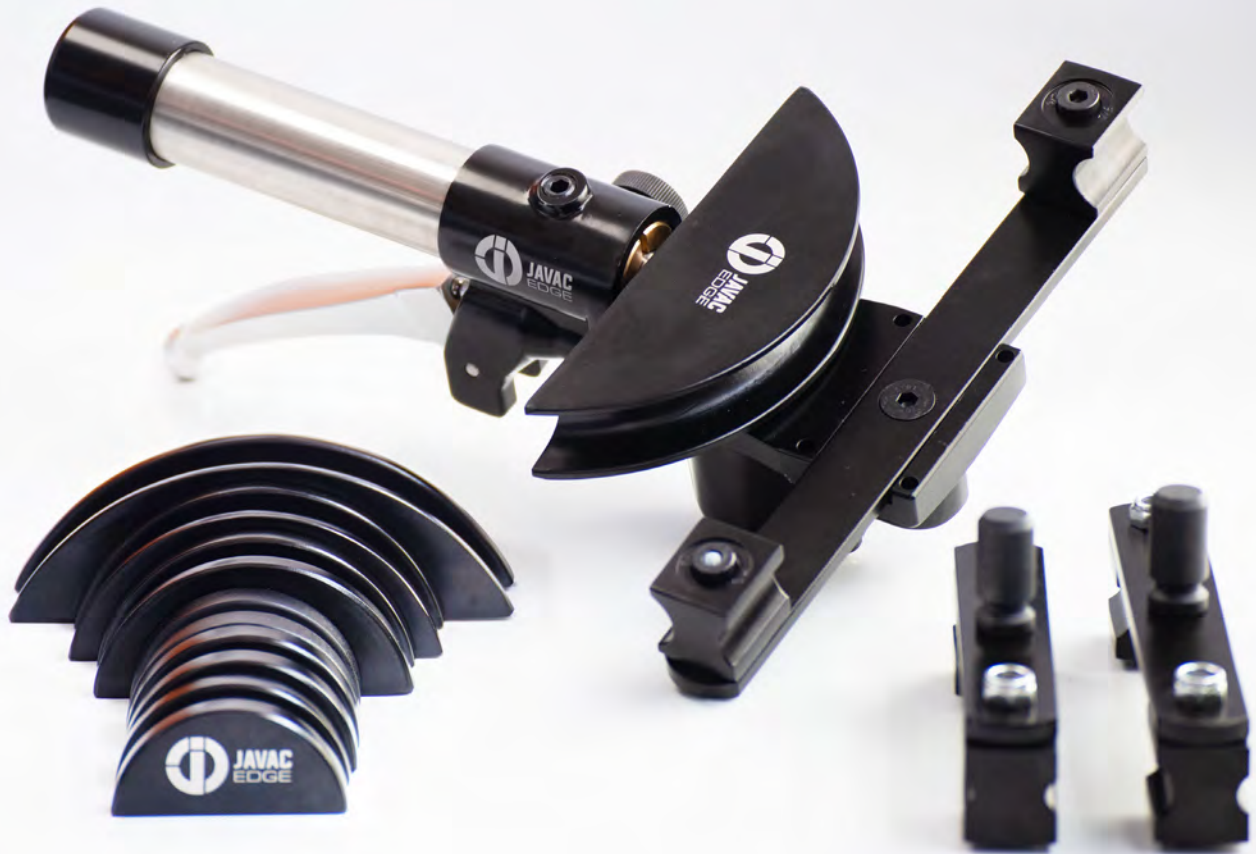

HYDRA-MB7 Hydraulic Bender



- Delivers accurate bends for both imperial and metric soft copper pipe
- Ergonomic and robust in design
- Hand wheel hydraulic quick release
- Steel formers and counter formers
- 1/4", 5/16", 3/8", 1/2", 5/8", 3/4", 7/8"
- Quick change between sizes
- Delivered as a complete kit, with spare former and counter formers available
- Hard plastic carry case
- Only for use on soft drawn copper

Description	Part No.
HYDRA-MB7 Hydraulic Bender	JAV-1394

Kit includes:

1 x Hydraulic Bender Tool, 1 each of 7 Formers – 1/4", 5/16", 3/8", 1/2", 5/8", 3/4", 7/8" (6mm – 22mm)

HYDRA-MB7 Spares	Part No.
1/4" Former	JAV-1395
5/16" Former	JAV-1396
3/8" Former	JAV-1397
1/2" Former	JAV-1398
5/8" Former	JAV-1399
3/4" Former	JAV-1400
7/8" Former	JAV-1401
1/4 – 5/16 Counter Former	JAV-1402
3/8 – 1/2 – 5/8 Counter Former	JAV-1403
3/4 – 7/8 Counter Former	JAV-1404

Information correct at time of going to press. Not all products are available in all regions.



HYDRA-XP9 Hydraulic Expander



- Universal for imperial and metric pipe
- Single-handed operation
- Compact design permits working in hard to access areas
- Laser-engraved expander heads are easy and quick to identify and attach
- De-burring tool included in the kit
- Angled and ergonomic design requires less effort
- Hard plastic carry case
- Spare heads available
- Only for use on soft drawn copper

Description	Part No.
HYDRA-XP9 Hydraulic Expander – imperial	JAV-1405

Kit includes: 1 x Hydraulic Expander Tool, 1 x Deburring Tool, 1/4", 3/8", 1/2", 5/8", 3/4", 7/8", 1 1/8", 1 3/8", 1 5/8"

HYDRA-XP9 Hydraulic Expander – metric	JAV-1434
---------------------------------------	----------

Kit includes: 1 x Hydraulic Expander Tool, 1 x Deburring Tool, 1 each of 9 Heads – 6, 10, 12, 16, 18, 22, 28, 35, 42 mm

Dimensions	L: 250 mm W: 45 mm H: 120 mm
Weight	2.6 lbs (1.2 kg)
Suitable for	Soft pipes only: copper, aluminium, brass

Spares			
Size	Part No.	Size	Part No.
1/4"	JAV-1406	6 mm	JAV-1435
3/8"	JAV-1407	10 mm	JAV-1436
1/2"	JAV-1408	12 mm	JAV-1437
5/8"	JAV-1409	16 mm	JAV-1438
3/4"	JAV-1410	18 mm	JAV-1439
7/8"	JAV-1411	22 mm	JAV-1440
1 1/8"	JAV-1412	28 mm	JAV-1441
1 3/8"	JAV-1413	35 mm	JAV-1442
1 5/8"	JAV-1414	42 mm	JAV-1443

Information correct at time of going to press. Not all products are available in all regions.



JAV-1016 3/8"

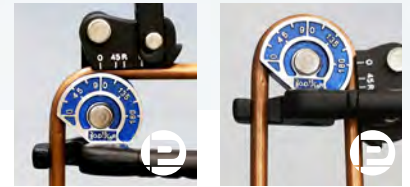

Dual hinge design

Tube Benders

MULTI SIZE



- Patented Dual Hinge Design – resets the handle position for extra leverage, making the second bend to 180° so simple.
- For use on soft drawn copper only



JAV-1019 3/4"

Sizes OD	Part No.	Sizes OD	Part No.
3/8"	JAV-1016	10mm	JAV-1177
1/2"	JAV-1017	12mm	JAV-1178
5/8"	JAV-1018	15mm	JAV-1179
3/4"	JAV-1019	16mm	JAV-1180
7/8"	JAV-1020	18mm	JAV-1181
		22mm	JAV-1182

Information correct at time of going to press. Not all products are available in all regions.

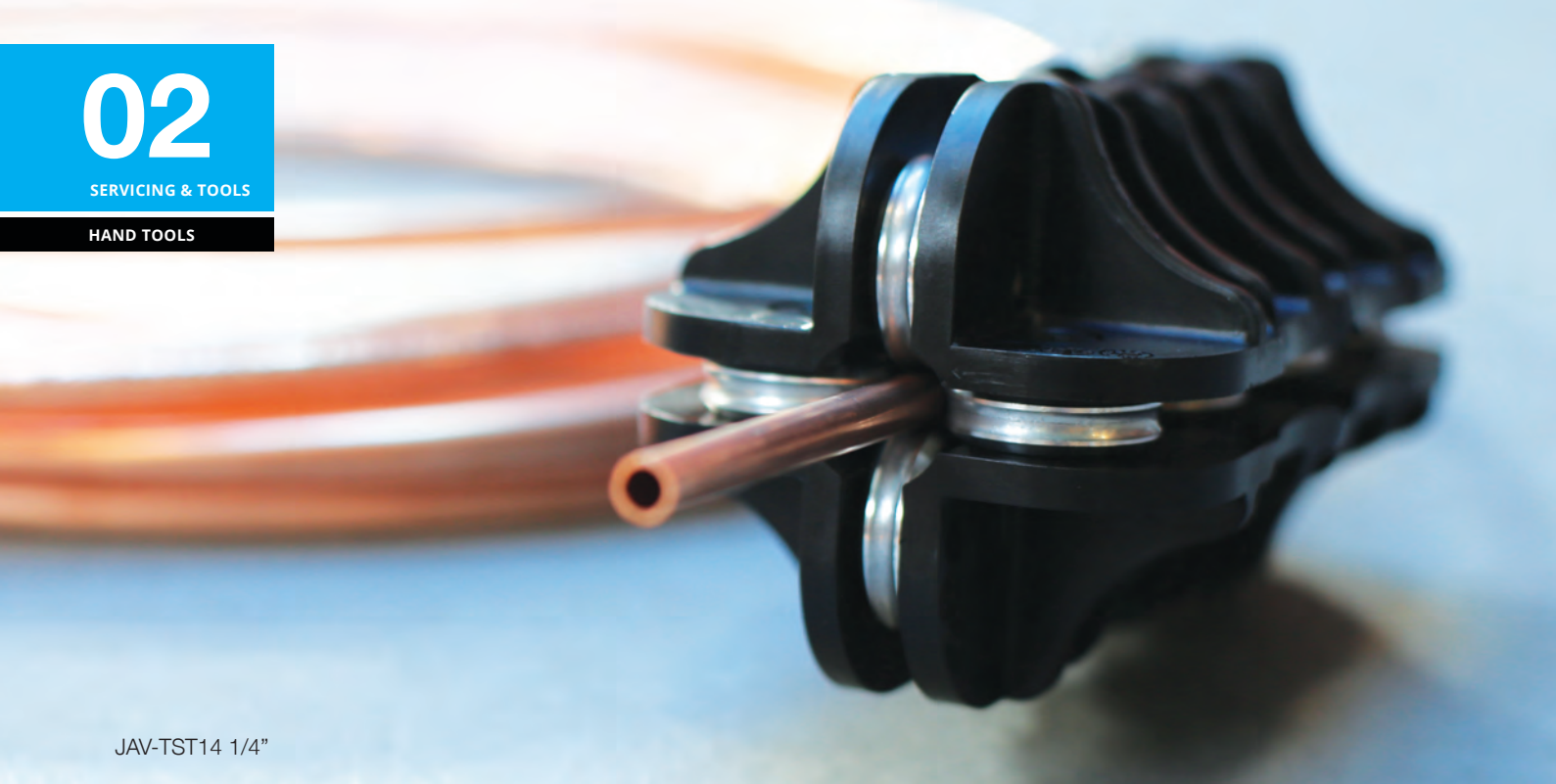

JAV-TST14 1/4"

Tube Straightener



- Accurately straightens light wall tube from coil
- Straighten what you need – less material wastage
- Accelerated flow for better efficiencies from straighter pipe
- Rollers spiral along the tube to straighten and strengthen the tube
- Create radius tube bends using the central hole
- For use on soft drawn copper only

Sizes OD	Part No.
1/4"	JAV-TST14
3/8"	JAV-TST38
1/2"	JAV-TST12
5/8"	JAV-TST58
6mm	JAV-1035
10mm	JAV-1036

Bending Kit



- Facilitates bending of copper pipe
- Prevents the pipes from crushing during installation
- Avoids system failure due to pipe crushing
- Easy removal
- Reusable for multiple installations
- Reusable closure straps.

Part No.	Ø COPPER TUBE
9899-851-00	1/4" + 3/8", 6.35 + 9.52 mm
9899-852-00	1/2" + 5/8", 12.7 + 15.87 mm
9899-850-00	1/4" + 3/8" + 1.2" + 5/8" 6.35 + 9.52 + 12.7 + 15.87 mm

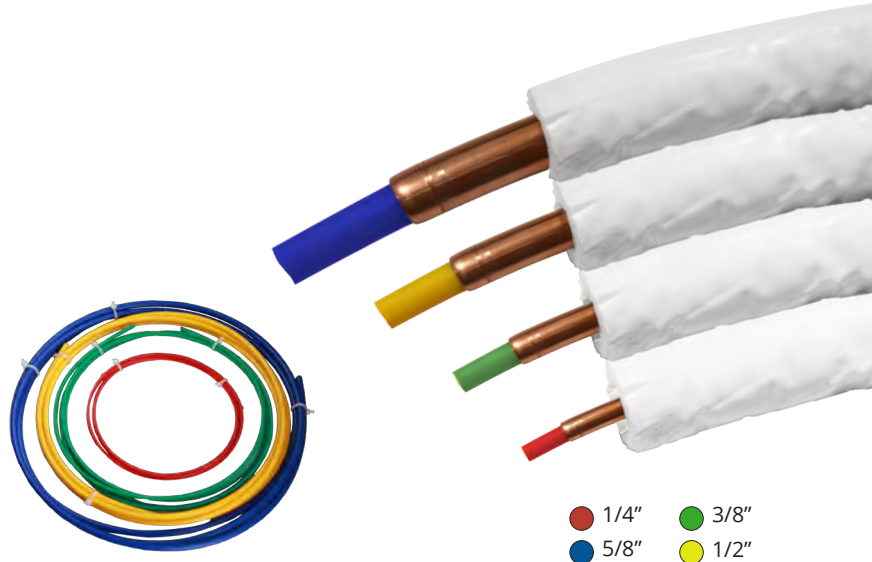

- 1/4" • 3/8"
- 5/8" • 1/2"

Information correct at time of going to press. Not all products are available in all regions.



Digital Torque Wrench



- Adjustable head
- Digital torque value readout
- +/- 2% accuracy
- CW and CCW operation
- Peak hold and track mode selectable
- Buzzer and LED indicator for the 9 pre-settable target torques
- Water contact indicator
- Engineering units (N-m, ft-lb, in-lb, kg-cm) selectable
- 50 or 250 data memory for recall and joint torque auditing
- Auto Sleep after about 5 minutes idle
- Compatible with rechargeable batteries
- Hard plastic carry case

Part No.	Square Drive	Max. Torque
JAV-1356	3/8"	85 N-m / 62.7 ft-lb / 752 in-lb / 867kg-cm

Accuracy	Torque Measuring Range (N-m)	Length
B +/-2%-CW / +/-3%-CCW	4.2~85	270mm

Accuracy	BN	BR
	CW : ±2% CCW : ±3%	
Data memory size	50	250
PC Connectivity	No	No
Pre-Setting No.	9 sets	
Bright LED	6 LEDs (1 Red + 5 Green)	
Operation Mode	Peak hold/Track	
Unit Selection	N-m, in-lb, ft-lb, kg-cm	
Head Type	Adjustable wrench head	
Gear Teeth	52	
Size of Head of End Fitting (WxH)	9 x 12mm	
Axial Distance	17.5mm	
Button	5	
Battery 3	AAA x 2	
Operating Temperature	-10°C ~ 60°C	
Storage Temperature	-20°C ~ 70°C	
Humidity	Up to 90% non-condensing	
Drop Test	1m	
Vibration Test	10G	
Environmental test	Pass	
Electromagnetic compatibility test	Pass	

Information correct at time of going to press. Not all products are available in all regions.



JAV-1358

Piercing Plier



Designed to immediately pierce into any charging tube on all HVAC/R systems, mostly used in domestic applications

- Once the tube is pierced simple charging or evacuation can be carried out with minimal fuss
- Once complete the tube can be pinched off with the JAVAC Pinch off plier (JAV-1357) and the system can then be sealed

Description	Part No.
Piercing Plier	JAV-1358
Spare Needles (x10)	JAV-1359

Pinch Off Plier



The JAVAC Pinch Off Pliers are designed to pinch off copper tube up to 8mm thickness

- Locking jaw
- Pinches off and locks in place

Description	Part No.
Pinch off plier	JAV-1357



Information correct at time of going to press. Not all products are available in all regions.

02

SERVICING & TOOLS

HAND TOOLS



SPL-350 | SPIRIT LEVEL WITH WORKLIGHT

- 350 Lumen LED spirit level worklight
- Light-up spirit level vial & red laser pointer
- Tough ABS & aluminium construction
- Glow-in-the-dark strip around the LED
- Strong rear & side magnets
- Strong holster with belt clip
- Smart Memory – remembers last mode used
- IPX4 water resistant
- High quality 3.7v 800mAh Li-ion battery
- Battery level & charging indicator
- Low battery warning flash, reminds to charge
- Fast 2A USB-C charging – 1.5 hr charge time
- 1m high quality USB-C charging cable included

BATTERY	3.7v 800mAh Li-ion
WEIGHT	177g
DIMENSIONS	H 55 x W 90 x D 20mm



LUMEN 350LM | RUNTIME 1-25H | BEAM 23M | IP RATING IPX4

Information correct at time of going to press. Not all products are available in all regions.



MT5M2 | HEAVY DUTY TAPE MEASURE

- Heavy duty 5m tape measure with 27mm wide blade
- Ultra high performance nylon coated SUPERBLADE - 5 x extended life
- 2.9m/9.5ft high stand-out blade
- SUPERBLADE withstands durability tests of falling sand particles with 60 litres of salt spray for 100 hours
- Magnetic triple riveted stainless steel dual hook with 1kg suction
- Dual colour double sided imperial & metric blade
- Durable rear pocket clip - wont detach even if screw loosens
- Powerful push lock secures the blade
- Superior internal mechanism provides smooth operation
- Impact resistant TPR covered ABS casing
- Drop tested from 9m



WEIGHT 322g | **DIMENSIONS** H 76.5 x W 79 x D 51.8mm

Information correct at time of going to press. Not all products are available in all regions.

02

SERVICING & TOOLS

CUTTERS



UK1 | FOLDING UTILITY KNIFE

- Heavy duty nickel body with ABS and a TPR grip
- 4 x SK5 black steel blades included
- 1 blade installed and 3 replacement blades conveniently stored inside
- Multi-position folding design
- Easy press unlocking button
- Quick release blade change
- Convenient wire/strap cutter slot
- Useful hole for attaching a lanyard
- Accepts most standard utility blades
- Extended size H 175 x W 33 x D 23.5mm



WEIGHT 125g | **DIMENSIONS** H 116 x W 41.5 x D 23.5mm

Information correct at time of going to press. Not all products are available in all regions.

02

SERVICING & TOOLS

CUTTERS



EK4 | HEAVY DUTY FOLDING UTILITY KNIFE

- Heavy duty folding utility knife
- High-carbon 3Cr13 stainless steel blade
- 'Drop point' blade with serrated edge and tapered spine swedge
- Blade spine includes thumb rise for extra grip and 2 wire stripper notches
- Assisted one-handed opening with thumb studs
- Blade hardness 52-55 HRC
- Ultra tough ergonomic aluminium handle with front Quillion finger guard
- Easy to operate one-handed 'Framelock' mechanism
- Pocket clip for easy carrying

 **UNILITE**

WEIGHT 135g | **DIMENSIONS** Length: 195mm

Information correct at time of going to press. Not all products are available in all regions.

02

SERVICING & TOOLS

CUTTERS



FK3 | HEAVY DUTY FOLDING UTILITY KNIFE

- Heavy duty folding utility knife
- High-carbon 3Cr13 stainless steel blade
- 'Clip point' blade with serrated edge and tapered spine swedge
- Blade spine includes thumb rise for extra grip
- Blade hardness 52-54 HRC
- Assisted one-handed opening with thumb studs
- Easy to operate one-handed 'Liner lock' mechanism
- Ultra tough ergonomic aluminium handle with front Quillion finger guard
- Pocket clip for easy carrying
- Hole in the handle for adding a lanyard

 **UNILITE**

WEIGHT 119.5g | **DIMENSIONS** Length: 198mm

Information correct at time of going to press. Not all products are available in all regions.



Quick-release control



Trolley system



Portable Lifter 3.7m



The ultimate solution designed to assist with the lifting and positioning of heavy equipment in the HVAC industry.

- The lifter is suitable for use with condensers, evaporators, ductwork, air handling units, pipework plus many other uses
- Featuring its extendable legs, wide platform base and robust design the lifter offers unparalleled suitability and adaptability for almost all HVAC lifting and positioning requirements
- Designed to endure tough conditions allowing you to work safely, securely and efficiently

Description	Part No.
Portable Lifter 3.7m	JAV-1353

Kit includes: 1 x Platform, 1 x Telescoping mast, 1 x Pulley with pulley cover, 1 x Steel cable, 1 x Motor and gearbox, 1 x Sliding ring, 4 x Legs, 2 x Wheel, 1 x Lever to select going up or down, 1 x Emergency Stop push button, 1 x Trigger button to control speed, 1 x Wheeled bag

Operational Voltage	220V ~ 240V @ 50/60Hz
Operation Current	4 Amp
Motor Duty	S3 30%
Plug Type	EU plug and UK plug adaptor
Max. Load Capacity	130kgs (3.0m height)
Basic Height	1m
Lifting Height	3.69m
Standard Platform	75 x 44cm
Operating Size	115 x 118cm
Length of controlling cable	4m
Length of power cord	2.7m
Ambient temperature	-5 °C to 45 °C
IP Level	IP43
Packaging box size	102 x 28 x 33cm
Weight	33.8 kgs
Accessories	Manual Handle
Safety Standard	EN 60204-1:2018 / EN ISO 12100:2010
Compliance	WEEE / CE / UKCA

Information correct at time of going to press. Not all products are available in all regions.



Portable Lifter 5m



Engineered to minimise manual handling risks and enable safe raising and lowering of condensers, evaporators, duct work, air handling units and more. Built with a rugged construction to endure tough site conditions, complete with an innovative base featuring a small set of wheels to allow for easier transportation. The addition of a quick release cable brings easier operation and storage, with an optional remote control unit available to give even more practical possibilities.

- Load Capacity - 140kg @ 3m, 130kg @ 4m and 90kg above 4m.
- Folding Aluminium Platform - strong but low weight and hard wearing.
- Quick Release 5m Cable - makes storage and set up quicker and easier. No messy cables to store.
- Comes complete in a robust carry bag to protect and store safely.
- Robust aluminium telescoping mast and four folding support legs ensure safe and secure operation. Each leg is versatile, and able to be adjusted individually, so perfect for uneven ground.
- Built-in spirit level to ensure correct set up before lifting.



JAV-1559
Remote Control

Description	Part No.
Portable Lifter 5m	JAV-1352

Optional Extra	Part No.
Remote Control	JAV-1559

Enables single person operation from a safe working distance on the ground, rooftops or windows.

Operational Voltage	220 V
Max. Load Capacity	140 kg/3m, 130kg/4m, 90kg/over 4m
Basic Height	1.17 m
Lifting Height	4.95 m
Operating Size	148 x 140 cm
Weight	36 kg

Information correct at time of going to press. Not all products are available in all regions.

03

RECOVERY, VACUUM & CHARGING

Recovery Units	58-62
Vacuum Pumps	63-65
Ultimate Hi-Flow	66-71
Hose	72-76
Kits	77
Manifolds	78
Gauges & Oils	79-80
Thermometers	81
Scales	82-83
Nitrogen	84-87
Accessories	88



ASPEN
PUMPS
GROUP



Velo-X Twin Cylinder Recovery Unit



The JAVAC Edge Velo-X. Our first recovery unit fully compatible with all A2L and A3 refrigerants. Industry leading recovery rates and JAVAC reliability giving our quickest and most efficient solution yet.

- R32 / R1234YF / HFC / HCFC / CFC / HFO / A2L / A3
- Lightweight complete with shoulder strap
- LED indicator showing recovery and machine status
- 5m hard wired cable and spark proof switch
- Dual gauge monitoring shows the tank and system pressures with integrated low pressure auto-off switch.
- Intelligent safety sensing
- Includes reusable mesh particulate filter for the suction port which can be easily cleaned or replaced

Recovery Rates (R410a)

Liquid	377kg per hour
Vapour	20kg per hour
Push / Pull	408kg per hour

Description	Part No.
Velo-X Twin Cylinder Recovery Unit	JAV-1424
Power supply	Universal Voltage 100-240VAC 50/60Hz
Motor size	1.25 HP
Motor Type	Variable Speed Brushless DC, 1500-3000 rpm
Maximum current	12.0 amps
Compressor	2 Cylinder Oil-less Reciprocating, Air Cooled
High Pressure Cutout (Manual reset)	550 PSIG
Operating Temperature Range	0 to 49 °C
Dimensions	370 x 245 x 325 mm
Weight	13,8 kg

Information correct at time of going to press. Not all products are available in all regions.



XTR-Ultra A2L

REFRIGERANT RECOVERY UNIT



- Ultra lightweight – 8.4kg
- Ultra fast liquid recovery rate – 120kg/hr
- Spark proof design: 5 m hard wired cable
- Suitability A2L, HFC, HCFC & CFC

Suitability	A2L / HFC / HCFC / CFC
Push/Pull (kg/hr)	420
Vapour (kg/hr)	19
Liquid (kg/hr)	120
Power supply	240 V
Motor size	3/4 HP
HP cut out	550 psi (38 bar)
Compressor	Oil less
Weight	8.4kg
Dimensions	320 x 220 x 260mm

Description	Part No.
XTR-Ultra A2L Recovery Unit UK	XTR-ULTRA-A2L

Information correct at time of going to press. Not all products are available in all regions.



HC-3 Hydrocarbon



- Liquid and vapour recovery with automatic changeover
- Self discharging and Hot Gas/Cool Gas discharge switch
- On board refrigerant storage facility – capacity 250g
- Automatic high and low pressure safety switches and manual low pressure override switch
- 110V and 240V models available
- Compressor protection, HP switch plus thermal overload

Description	Part No.
HC-3 Hydrocarbon	JAV-1032
Suitability	R22, R134A, R404A, R407C, R410A, R413A, R417A, R502, R600A, R290, R1234YF, R32 & all CARE® blend refrigerants
Recovery (kg/hr)	32
Power supply	240 V
Motor size	145W
HP cut out	360 psi (25 bar)
Compressor	Hermetic oil-lubricated, air cooled
Weight	21kg
Dimensions	470 x 235 x 335mm



For use on A3 please scan the QR code to read the A3 safety instructions. **DO NOT USE UNLESS FULLY QUALIFIED FOR A3.**

Information correct at time of going to press. Not all products are available in all regions.



HC-Air Fan Ventilation Module



- The HC-Air fan module is an essential service accessory to be used when transferring hydrocarbon refrigerant and should feature in the risk assessment process
- Commutated motor
- 5 m hard wired mains lead with moulded plug
- Non sparking thermoplastic fan blade for increased performance and reduced noise level
- Mains cable storage
- Robust painted steel casework

Description	Part No.
HC-Air Fan Ventilation Module	JAV-1033
Airflow	700 m ³ /h
Power supply	230 V 50Hz
Power Absorbed	25W
Fuse Protection	3A
Ambient temperature rating	-20°C to 55°C
Weight	6.48kg
Dimensions	300 x 220 x 380mm



For use on A3 please scan the QR code to read the A3 safety instructions. **DO NOT USE UNLESS FULLY QUALIFIED FOR A3.**

Information correct at time of going to press. Not all products are available in all regions.



Anti-oil demister to prevent oil-mist



Intake fittings

Bulldog A2L/A3

SPARK PROOF VACUUM PUMP



- Spark proof design: 5 m hard wired 240 V cable
- Two stage oil sealed vacuum pump
- Isolation solenoid valve
- Dual oil mist filters to prevent oil mist
- Unique tri-connector offers three hose fittings designed to cover a broad range of application capabilities

Suitability	All standard and A2L/A3 applications
Stage	Double
Ultimate vacuum	15 Microns
Free air displacement	156 l/m (5.5 CFM)
Power supply	240 V 50Hz
Motor size	2880 rpm
Power cord	5 m, Glanded
Oil capacity	450ml
Intake fittings	1/4", 5/16", 3/8" SAE
Weight	12.5kg
Dimensions	338 x 212 x 238mm

Description	Part No.
Bulldog A2L	VBD1622



For use on A3 please scan the QR code to read the A3 safety instructions. **DO NOT USE UNLESS FULLY QUALIFIED FOR A3.**

Information correct at time of going to press. Not all products are available in all regions.



CC Series A2L/A3

SPARK PROOF VACUUM PUMPS



- High performance A2L / A3 range
- Sparkproof switches
- Hard wired 5m Lead
- Dual Voltage
- Solenoid valve
- Easy Access oil drain



For use on A3 please scan the QR code to read the A3 safety instructions. **DO NOT USE UNLESS FULLY QUALIFIED FOR A3.**



Part No.	CC-31 A2L	CC-141 A2L	CC-231 A2L
Suitability	All standard and A2 / A3 applications		
Stage	Double		
Ultimate vacuum	15 microns		
Free air displacement	40 l/m (1.4 CFM)	151 l/m (5.3 CFM)	251 l/m (8.9 CFM)
Power supply	Dual voltage 110/240 V 50Hz		
Motor size	1/4 HP	1/2 HP	2/3 HP
Power cord	IEC		
Oil capacity	140 ml	540 ml	620 ml
Intake fittings	1/4" SAE, 3/8" SAE		
Weight	4.5 kg	11 kg	14.8 kg
Dimensions	265 x 105 x 220 mm	348 x 140 x 272 mm	380 x 160 x 285 mm

Information correct at time of going to press. Not all products are available in all regions.

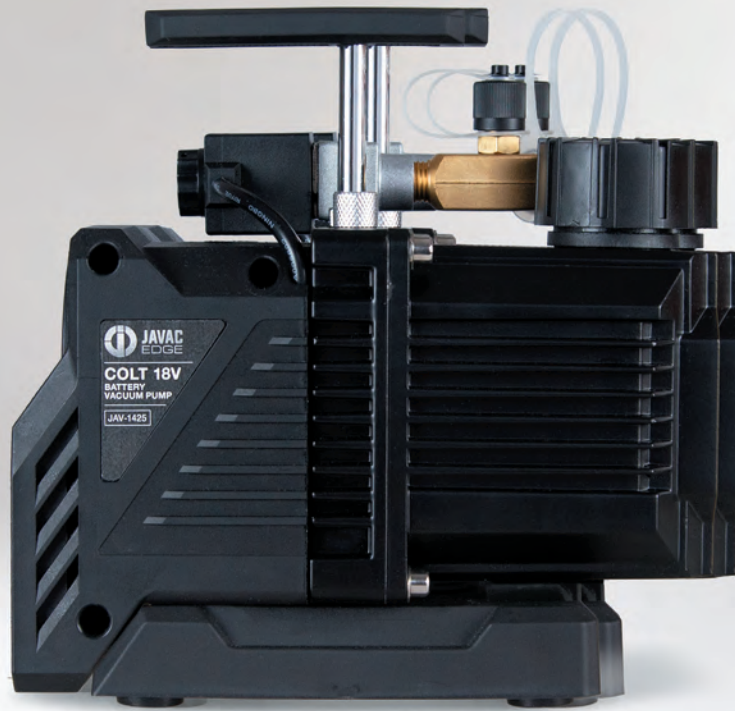

Colt 18V A2L/A3

SPARK PROOF BATTERY VACUUM PUMP



- Anti-oil-returning design + Solenoid Valve
- Anti-oil demister to prevent oil spillage
- 2CFM, 18V Brushless DC Motor
- 55 l/min, Oil circulation design
- Pump Only, Battery not included
(Battery Adaptors included for Milwaukee and Makita)

Suitability	All standard A2L and A3 applications
Power supply	18v, 5.0Ah Battery Powered
Ultimate vacuum	30 microns (4 Pa)
Free air displacement	55 l/m (2.0 CFM)
Motor size	4000 rpm
Oil capacity	140ml
Intake fittings	1/4" and 3/8"
Weight	3.1kg
Dimensions	190 × 105 × 192 mm

Description	Part No.
Colt 18V Battery Vacuum Pump	JAV-1425



For use on A3 please scan the QR code to read the A3 safety instructions. **DO NOT USE UNLESS FULLY QUALIFIED FOR A3.**

Information correct at time of going to press. Not all products are available in all regions.



INTRODUCING ULTIMATE HI-FLOW TOOL RANGE

The new Ultimate Hi-Flow tool range strengthens the Javac Edge brand with a cutting-edge line up of professional-grade tools engineered for speed, reliability and performance. Designed to streamline both set up and operation, the range dramatically improves efficiency during system evacuation and refrigerant recovery.

Precision-machined from aircraft-grade aluminium and finished with a durable anodised coating, these tools deliver exceptional strength while remaining lightweight and portable - built to perform on site, job after job.

Innovative designs enable fast core valve removal for completely unrestricted refrigerant flow, while high linear-flow fittings support multiple hose connections for maximum throughput. The result is faster evacuation, quicker recovery times, and reduced downtime on every job.

Every product in the range is deep vacuum rated to 20 microns with a maximum working pressure of 800 *psi* (55*bar*), providing engineers total confidence in the most demanding applications.

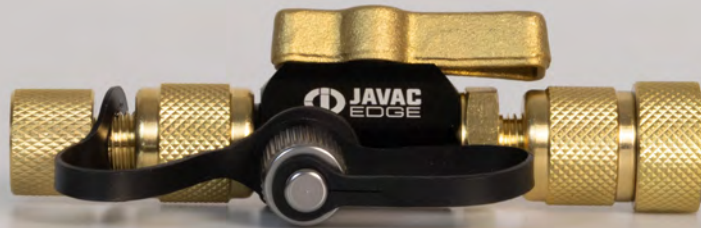

Hi-Flow Core Removal Tool



The Ultimate Hi-Flow Core Removal Tool is a professional-grade, vacuum and pressure-rated valve core removal accessory designed for HVAC/R service, refrigerant recovery, and system evacuation. By removing restrictive valve cores, it provides true full-flow system access, significantly increasing both recovery and evacuation speed as well as the achievable depth of vacuum. It also allows connection to a vacuum gauge as close as possible to the unit being evacuated. This tool will improve service time on any system that relies on a Schrader valve for refrigerant access.

Key Features & Benefits:

Full-flow valve core removal – Eliminates core restriction for maximum flow, faster recovery/evacuation, and deeper vacuum.

Deep-vacuum rated – Maintains leak-free performance under vacuum conditions.

High-pressure rated – Safe for charging and use with high-pressure refrigerants (e.g. R410A).

Magnetic base / secure handling – Prevents lost valve cores during service.

Core-retention removal mechanism – Securely grips and extracts cores to avoid loss.

Side-port connection – Enables gauges or hoses for evacuation, charging, or testing.

No tools required - Hand tighten only.

Two sizes in one tool - 1/4" and 5/16".

Refrigerant Ready - Compatible with A1, HFC/HFO, low GWP A2L and A3 refrigerants.

Description	Part No.
Ultimate Hi-Flow Core Removal Tool	JAV-1600

Specification	
Service Port	1/4" female flare (with 5/16" female for mini-split systems)
Core / Side Port	Both ports: 1/4" male flare with removable valve core
Vacuum Rating	20 microns. Ideal for system evacuation
Maximum Working Pressure	800 psi (approx. 55bar) matching higher pressure refrigerant system requirements (R410a)
Materials & Seals	Select materials compatible with common (e.g. HFC, HFO, A2L, A3) - HNBR O-rings / sealing elements (Super Seals) as well as proprietary PTFE long life ball valve seals
Core-Grip Mechanism	Adjustable tip to securely grab a range of valve core sizes for removal/re-installation
Side Port Functionality	Allows connection of vacuum pump, vacuum gauge or changing hose
Compatibility	Refrigerants including HFC, HFO, A2L & A3, recovery and evacuation

Information correct at time of going to press. Not all products are available in all regions.



Hi-Flow Core Removal Y Tool

Dual Valve with Sight Glass



The Ultimate Hi-Flow Core Removal Y Tool with Sight Glass and Dual Valve is a professional-grade, vacuum and pressure-rated valve-core removal accessory engineered for HVAC/R service, recovery, evacuation and charging tasks. It offers dual-valve functionality, high speed Y flow path for increased flow and a sight glass to witness core removal and installation as well as the safe control of refrigerant during system recovery and charging. Designed to speed up refrigerant recovery, evacuation, charging, reduce tool count, and improve workflow efficiency for technicians working on a wide range of systems.

Key Features & Benefits:

Dual-Valve with Side Port Isolation – Built-in ball valve isolates gauges or hoses for safer, more flexible servicing.

Y-Configuration – Creates linear flow for faster evacuation, recovery, and charging.

Sight Glass – Monitor core removal and refrigerant flow during service.

Full-Flow Core Removal – Eliminates restrictive valve core for maximum flow.

Deep Vacuum Rated – Leak-free performance under vacuum conditions. (20 microns)

Swappable Fittings – 1/4" standard and 5/16" for mini-splits for broad compatibility.

Core-retention removal mechanism – Securely grips and extracts cores safely.

Refrigerant-Ready – Compatible with A1, HFC/HFO, low-GWP A2L/A3 refrigerants.

Two Active Lines - Speed up system evacuation and refrigerant reclaim

Optimised Flow Paths - Large bore internal passages engineered for higher linear flow.

Description	Part No.
Ultimate Hi-Flow Core Removal Tool Y Tool Dual Valve	JAV-1601

Specification	
Service Port	1/4" female flare (5/16" female fitting for mini-split fitting applications)
Side Port/Core Removal Port	Both ports: 1/4" male flare with ball valve isolation
Vacuum Rating	20 microns. Ideal for system evacuation
Maximum Safe Working Pressure	800 psi (approx. 55bar) matching higher pressure refrigerant system requirements (R410a)
Material & Seals	Select materials compatible with common refrigerants (e.g. HFC, HFO, A2L, A3) - HNBR O-rings / sealing elements (Super Seals) as well as proprietary PTFE long life ball valve seals.
Handling/User Interface	Large rod/spinner for core removal; secure core retention; easy swap fitting design for 1/4" & 5/16"
In the box	Tool with additional 1/4" & 5/16" adaptor and standard 1/4" & 5/16" tethered fitting
Compatibility	Refrigerants including HFC, HFO, A2L & A3, recovery and evacuation

Information correct at time of going to press. Not all products are available in all regions.



JAV-1603

JAV-1602

JAV-1604

Hi-Flow Y Fitting Series



The Ultimate Hi-Flow Y Fitting Series are high performance vacuum rated Y adaptors built for HVAC/R evacuation, recovery and charging operations. Each one is designed to provide unrestricted high flow paths and flexible hose connections. Each of the three size combinations available enable engineers to connect multiple hoses to a single point - ideal for complex systems, multi port manifolds or multi hose recovery set ups.

Specification

Body Material	Aircraft grade aluminium - for strength, light weight and corrosion resistance, with solid brass connectors and flare faces
Connection Types	Two 3/8" male flare branches. Female flare swivel - branch size varies by model (3/8", 1/4" or 1/2")
Internal Bore/Flow Path	Large internal diameter branches engineered for high linear flow
Vacuum Rating	20 microns suitable for deep system evacuation.
Maximum Safe Working Pressure	800 psi (approx. 55bar) matching higher pressure
Material & Seals	High-quality solid brass flare sealing elements suitable for refrigerants (HFC, HFO, A2L, A3) and HNBR Super Seals.
Finish/Coating	Durable anodized finish to resist oxidation/corrosion - Ideal for field use in varied environments

Description	Part No.
Ultimate Hi-Flow Y Fitting Series	JAV-1602/1603/1604

Part Number	Connection Size	Usage
JAV-1602	3/8" x 3/8" x 3/8"	Hi-flow Y for systems where all connections are 3/8"
JAV-1603	3/8" x 3/8" x 1/4"	For set ups calling for 1/4" connection on vacuum pumps or reclaim units
JAV-1604	3/8" x 3/8" x 1/2"	For setups calling for a 1/2" connection for larger vacuum pump connections

Key Features & Benefits

- Unrestricted Flow** – High linear flow design for maximum throughput, significantly speeding up evacuation and recovery.
- Deep Vacuum Rated (20 microns)** – Leak-free performance, crucial for reliable evacuation.
- High-Pressure Compatible** – Engineered for use with high pressure refrigerants (R410a).
- Multi-Hose Connection** – Safe multi hose connection simplifying hose management.
- Durable Build** – Aluminium body, brass flare faces, and HNBR seals for long-term reliability.
- Compact Design** – Y-shaped form fits easily into tight spaces.

Information correct at time of going to press. Not all products are available in all regions.



Hi-Flow Bi-Valve Y Branch



The Ultimate Hi-Flow Bi-Valve Y Branch is a heavy-duty, vacuum and pressure-rated Y adapter fitting for HVAC/R applications. Designed to provide maximum flow capacity and flexible hose routing while also offering valve isolation for improved control and convenience. The bi valve configuration enables independent control of each of the two male flare branches, giving technicians greater flexibility when evacuating, charging, or servicing refrigerant systems.

Key Features & Benefits

Dual-Valve Design – Independent valves on each male flare branch for easy isolation and flow control.

Full-Flow Passage – Maximised bore size for faster evacuation, recovery, and charging.

Vacuum & Pressure Ready – Handles deep vacuum and high-pressure refrigerants reliably.

Flexible Hose Setup – Connect multiple hoses to one port for complex systems.

Durable Build – Aircraft-grade aluminium and brass for long life and corrosion resistance.

Compact Design – Y-branch form reduces bulk compared to traditional manifolds.

Description	Part No.
Ultimate Hi-Flow Bi-Valve Y Branch	JAV-1605

Specification	
Body Material	Aircraft grade aluminium - for strength, light weight and corrosion resistant, with solid brass connectors and flare faces
Connection Types	Two 3/8" male flare connections and one 3/8" female flare connection.
Internal Bore/ Flow Path	Enlarged and optimised internal flow paths giving high linear flow
Vacuum Rating	Deep vacuum (20 microns)
Maximum Safe Working Pressure	800 psi (approx. 55bar) matching higher pressure refrigerant system requirements
Valve type	Ball valves with long life proprietary PTFE seals
Material & Seals	High-quality flare connections and HNBR (Super seals) compatible with standard refrigerants (A1, HFC/HFO, A2L & A3)

Hi-Flow Tool Spares Kit



Description	Part No.
Ultimate Hi-Flow Tool Spares Kit	JAV-1610

Kit contains: HNBR O rings to suit the full range. One to service the 1/2" port, and two each to suit 3/8", 5/16" and 1/4" applications. Spare Caps to suit 5/16" and 1/4" ports (one of each size)

Information correct at time of going to press. Not all products are available in all regions.



JAV-1609

JAV-1608

Hi-Flow Access T Fitting



The Ultimate Hi-Flow Access T Fittings are vacuum and pressure rated T adaptor designed for HVAC/R service, charging, evacuation or diagnostic work. Available in two sizes they provide a compact and low loss access point for gauges, vacuum pumps or reclaim units. With their light and compact design they are ideal to tap into a system without the need for bulky manifolds or unnecessary extra hoses.

Part Number	Connection Size	Typical Usage
JAV-1608	1/4" female flare	Standard service fittings and systems using 1/4" flare connections
	1/4" male flare	
	1/4" male flare side port	
JAV-1609	5/16" female flare	For systems using larger 5/16" service fittings - especially in mini-split applications
	5/16" male flare	
	5/16" male flare side port	

Key Features & Benefits

Low-Loss Charging T – Enables charging, evacuation, or diagnostics with minimal refrigerant loss—no bulky manifold needed.

Side Port – Quick connection for gauges, pumps, or hoses without disconnecting the main service port.

Vacuum & Pressure Rated – Safe for deep vacuum and high-pressure operations (up to 800psi / 55bar).

Compact Design – Ideal for use in tight spaces.

Efficient Access – Simplifies hose management and speeds up work in any environment.

Description	Part No.
Ultimate Hi-Flow Access T Fitting	JAV-1608/1609
Specification	
Body Material	Aircraft-grade aluminium for strength, light weight, and anodised for corrosion resistance
Both Male Ports	1/4" or 5/16" male flare connection for gauges or service hose attachment
Maximum Safe Working Pressure	800psi (/ 55bar) matching higher pressure refrigerant system requirements (R410a)
Material & Seals	High-quality flare connections and HNBR (Super seals) compatible with standard refrigerants (A1, HFC/HFO, and where applicable A2L & A3)
Vacuum Capability	Engineered for deep vacuum operations (20 microns rated)
Finish/ Coating	Durable finish or coating to resist wear, corrosion and optimise field lifespan

Information correct at time of going to press. Not all products are available in all regions.



JAV-1606

JAV-1607

Hi-Flow Core Depressor Tool



The Ultimate Hi-Flow Core Depressor Tools - precision engineered vacuum and pressure rated core depressor accessories for HVAC/R service. Available in two size combinations, they enable safe and controlled valve core depression on Schrader fittings. Ideal when charging, recovering or servicing refrigerant systems and minimising refrigerant loss, protecting equipment and removing the risk of user front burns.

Specification

Side-Port/ Hose/ Gauge Connection	JAV-1606 - 1/4" flare connections for Schrader valve and service hose attachment. JAV-1607 - 5/16" flare connections for Schrader valve and service hose attachment.
Vacuum Rating	Deep vacuum capable (20 microns)
Maximum Safe Working Pressure	High-pressure rated (up to 800 psi/55 bar) - safe for higher-pressure refrigerants (R410a)
Seals/ Internal Components	High-quality O-rings / back-seat seals compatible with modern refrigerants (HFC, HFO, A2L, A3)
Body Material	Aircraft-grade aluminium - for strength, corrosion resistance, and longevity

Description	Part No.
Ultimate Hi-Flow Core Depressor Tool	JAV-1606/1607

Part Number	Connection Size	Typical Usage
JAV-1606	1/4" female flare 1/4" male flare side port	Schrader valve for connection of gauges or service hoses
JAV-1607	5/16" female flare 5/16" male flare side port	Schrader valve for connection of gauges or service hoses

Key Features & Benefits

- Accurate Core Control** – Smooth, precise core depression for negligible refrigerant loss while eliminating the risk of user frost burn.
- Vacuum & Pressure Rated** – Reliable under deep vacuum and high-pressure conditions. (20 microns)
- Low-Loss Side Port** – Connect gauges or hoses with negligible discharge for diagnostics and charging.
- Durable Build** – High-quality aluminium, brass, and HNBR seals for long-term reliability.
- Compact Design** – Ideal in tight spaces.

Information correct at time of going to press. Not all products are available in all regions.

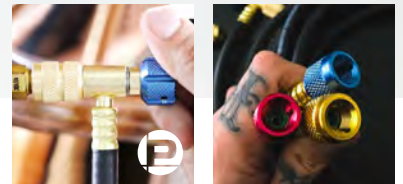

Safety Swivel
One-touch design *

Safe Seal

CHARGING HOSES



Patented Safe Seal technology: 'One-Touch' design allows you to screw the fitting on to the system before starting refrigerant flow, avoiding refrigerant loss and risk of 'refrigerant burn'. Then simply turn the knob to start/stop flow.

- 72" hose (183cm), Suitable for standard refrigerants.
- The safety swivel sleeve allows free rotational movement of the hose without the fitting coming loose being put under unnecessary strain and preventing unwanted leaks

*Photo credit @hvac_spark

Description	Part No.
Charging Hoses, Safe Seal, 1/4", Working Pressure: 600/3000 PSI (41 bar) Bursting pressure of 3000 psi (207 bar)	JAV-1071
R410A/R32 Charging Hoses, Safe Seal, 1/4" x 5/16", Working Pressure: 800/4000 PSI (55 bar). Bursting pressure of 4000 psi (276 bar)	JAV-1072
Safe Seal Hose Gaskets	Part No.
Safe Seal Gasket Manifold End 1/4" (10 pack)	JAV-1275
Safe Seal Gasket Serve End 5/16 x 1/4" (10 pack)	JAV-1276
Safe Seal O-ring for 5/16"	JAV-1355
Safe Seal O-ring for 1/4"	JAV-1354

Information correct at time of going to press. Not all products are available in all regions.



Turbo Flow

VACUUM AND CHARGING HOSES



- Large bore vacuum and charging hose
- Designed specifically to increase speed, flow and efficiency when using vacuum pumps and refrigerant charging via the 3/8th access fittings
- Available in 60" (1525mm) and 72" (1828.8mm) lengths
- Connections: 3/8" x 3/8" and 3/8" x 1/4"
- Teflon sealed
- Used for all vacuum and refrigerant charging procedures

Max working pressure	55 Bar
Burst Pressure	275 Bar
Core depressor	No
Ball valve	No
Colour	Black

Length	Part No.
72" 3/8 Vacuum Hose	JAV-1362
60" 3/8 Vacuum Hose	JAV-1363
72" 3/8 x 1/4 Vacuum Hose	JAV-1364
60" 3/8 x 1/4 Vacuum Hose	JAV-1365

NEW! Gaskets	Part No.
JAVAC Edge Teflon Gaskets 3/8" T Flow (10 pack)	JAV-1374

Information correct at time of going to press. Not all products are available in all regions.



JAV-1550
1/2" Increased bore
size – faster and
deeper vacuum

1/2" Turbo Flow

VACUUM AND CHARGING HOSE



Faster, Deeper Vacuum – The oversized 1/2" bore hose increases flow rate, allowing for deeper and quicker vacuum drastically reducing system evacuation time.

Universal Compatibility – Works with any vacuum pump that has a 3/8" connection for seamless integration into your workflow.

High-Pressure Ready – Designed to handle all high-pressure refrigerants without collapsing or permeating under vacuum pressure.

Optimized for All Refrigerants – Ensures efficient system charging and evacuation across standard HVAC refrigerants.

Description	Part No.
1/2" 3/8 x 1/4 Vacuum Hose, 72" long	JAV-1550
Connections	1/4" and 3/8" SAE
Max. Working Pressure	44 Bar / 650 PSI
Min. Burst Pressure	222 Bar / 3200 PSI
Material	4 Ply Hose; HNBR Neoprene Seals
Vacuum Rated	Up to 20 Microns
Length	72"

Information correct at time of going to press. Not all products are available in all regions.

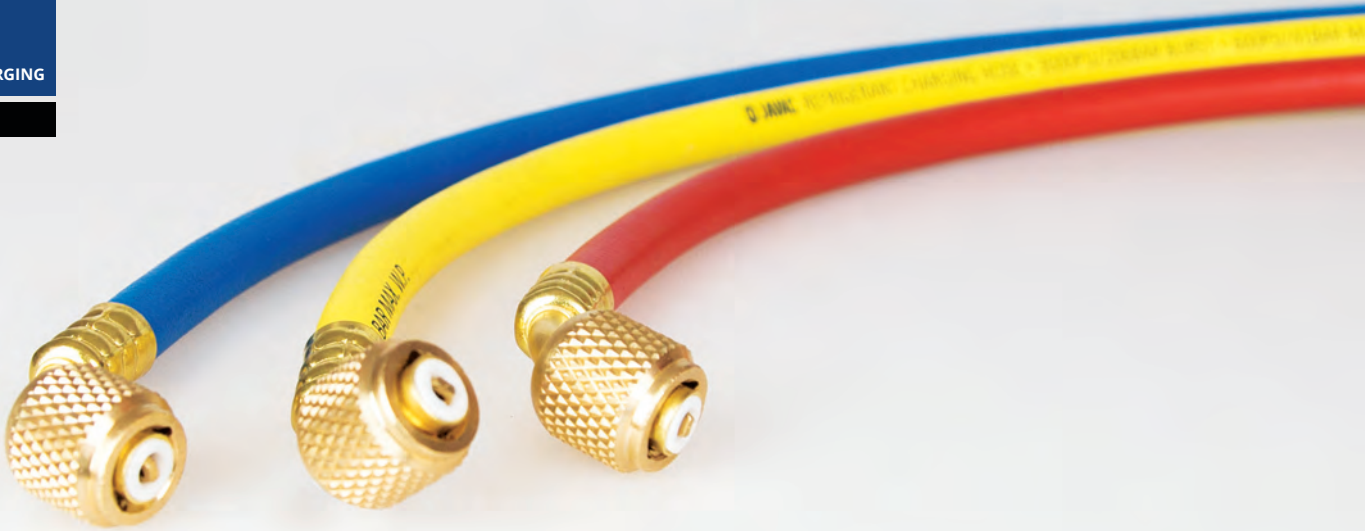

JAV-1375

Hose Sets

NO BALL VALVE, STANDARD & SET BACK



- Red/Yellow/Blue
- Temperature rating -30 to +95 oC



JAV-1381



JAV-1387

Part No.	Length / Type / Connections	No Ball Valve	Ball Valve Set Back	Standard Ball Valve	Burst pressure rating / Max working pressure Bar
JAV-1375	72" hose set 1/4" x 1/4"	✓	-	-	
JAV-1376	60" hose set 1/4" x 1/4"	✓	-	-	3000 PSI/206 / 600 PSI/41
JAV-1377	36" hose set 1/4" x 1/4"	✓	-	-	
JAV-1378	72" hose set R410a 1/4" x 5/16"	✓	-	-	
JAV-1379	60" hose set R410a 1/4" x 5/16"	✓	-	-	4000 PSI/275 / 800 PSI/55
JAV-1380	36" hose set R410a 1/4" x 5/16"	✓	-	-	
JAV-1381	72" hose set 1/4" x 1/4"	-	✓	-	
JAV-1382	60" hose set 1/4" x 1/4"	-	✓	-	3000 PSI/206 / 600 PSI/41
JAV-1383	36" hose set 1/4" x 1/4"	-	✓	-	
JAV-1384	72" hose set R410a 1/4" x 5/16"	-	✓	-	
JAV-1385	60" hose set R410a 1/4" x 5/16"	-	✓	-	4000 PSI/275 / 800 PSI/55
JAV-1386	36" hose set R410a 1/4" x 5/16"	-	✓	-	
JAV-1387	72" hose set 1/4" x 1/4"	-	-	✓	
JAV-1388	60" hose set 1/4" x 1/4"	-	-	✓	3000 PSI/206 / 600 PSI/41
JAV-1389	36" hose set 1/4" x 1/4"	-	-	✓	
JAV-1390	72" hose set R410a 1/4" x 5/16"	-	-	✓	
JAV-1391	60" hose set R410a 1/4" x 5/16"	-	-	✓	4000 PSI/275 / 800 PSI/55
JAV-1392	36" hose set R410a 1/4" x 5/16"	-	-	✓	

JAV-1366 Teflon gaskets for 1/4" & 5/16" Pack of 10

Gasket Picker



Description	Part No.
Gasket Picker	JAV-1367

Information correct at time of going to press. Not all products are available in all regions.



Supahose

STAINLESS STEEL REFRIGERANT HOSE



- Flexible PTFE lining surrounded by a braided AISI 304 / EN 1.4301 grade stainless steel wire
- Maximum working pressure of 260 bar
- Temperature Range: up to +260 °C
- 1/4" SAE Connection

Length	Part No.
12" (30,5cm)	120404
15" (38cm)	150404
18" (46cm)	180404
24" (61cm)	240404
30" (76cm)	300404
36" (91,5cm)	360404
48" (122cm)	480404
60" (152,5cm)	600404
78" (198cm)	780404

Information correct at time of going to press. Not all products are available in all regions.



TurboFlow Vacuum & Charging Kit

VETO + JAVAC EDGE ALL IN ONE BAG



This complete charging and evacuation kit, is designed to handle all high-pressure refrigerants and not to collapse or permeate under vacuum pressure.

- Truly universal to work with any vacuum pump with a 3/8" connection
- All products are vacuum rated so no leaks can occur when in ultimate vacuum
- All products are restriction free for complete TurboFlow state
- Significantly reduce evacuation times compared to a set up with a manifold and 1/4" hoses
- Can be used on all standard refrigerants to efficiently and quickly charge HVAC systems
- All items available available to buy seperately

Description	Part No.
TurboFlow Vacuum and Charging Kit	JAV-1422

Kit includes: 2 x JAV-1364 TurboFlow 3/8" FL to 1/4" FL black vacuum and charging hoses; 2 x JAV-1600 Hi-Flow JAVAC EDGE core removal tools 1/4" as standard with 5/16" adaptor; 1 x JAV-1415 JAVAC Edge Veloci-Tee 3/8" Vacuum and Charge Tee; 3/8"MF on the run; 1 x AX3685 Veto Pro Pac Hose Hauler bag

Hose Hauler Bag (AX3685) specifications	
Size (w/d/h)	430x130x430 mm
Weight (empty)	1.8kg
Storage/pockets	6 x pockets; 1 x removeable parts/gauges bag
Max. Payload	7kg
Internal volume	50.5L



AX3685



JAV-1600



JAV-1415



JAV-1364

Information correct at time of going to press. Not all products are available in all regions.



Manifold kit



Safe Seal Hoses

Manifolds



Brand new range of manifolds, available as two and four valve in standalone and kit configurations. R410a, R32, R600a and R290 variants are fully A3 compatible.

All manifolds:

- 1/4 turn control valves for fast operation and increased refrigerant flow
- Smart Spring valves to ensure perfect sealing
- Sight glass
- Forged aluminium body – durable and lightweight
- 80mm gauge heads with rubber protection surround
- Aluminium Valve Knobs for increased damage resistance
- JAVAC Edge Manifold hanging strap with strong magnet
- Available as manifold only or as a kit

Manifold Kit:

- Manifold
- JAVAC Edge 72” Safe Seal Hoses*
- Robust carry case with laser cut foam protection & manual

Gas	Product	Valve	Part No.
Multi Gas, R134A, R22, R404A, R407C	Manifold Only	2	JAV-1219
	Manifold Kit	2	JAV-1218

Gas	Product	Valve	Part No.
A3, R410a, R32, R600a, R290	Manifold Only	2	JAV-1217
	Manifold Kit	2	JAV-1216

Information correct at time of going to press. Not all products are available in all regions.



CO2 Service Manifold Kit

VETO + JAVAC EDGE ALL IN ONE BAG



Specifically designed for use on modern CO₂ (R744) refrigeration systems, where higher operating pressures demand equipment you can rely on.

- All packed in a Veto Pro Pac Hose Hauler bag
- Proven double O-ring piston control
- Large 80mm gauges fitted with rugged protection boots
- Supplied with 10 spare 1/4" flare washers (CD-109-04)
- Unique purge valve for improved safety - ensure no pressure is retained after use for safe storage and transportation
- 3 x double layer steel mesh hoses fitted with spring protection

Maximum Pressure	160 Bar (2320.604 PSI)
Dimensions	430 x 100 x 460mm
Weight	4.4kg

Description

CO2 160 bar manifold and hoses in a Veto Hose Hauler bag

Part No.

JAV-1558



Torr Gauge



- Stainless Steel construction
- Blow out plug for over pressure protection (available as a spare Part No. CR2-PLUG)

Description	Part No.
Torr Gauge	CR2-40

Accuracy	Class 2
Units	Torr, mbar
Operating pressure range	0 - 40 Torr / 50 mbar
Connector type	1/4" Flare connection
Diameter	100mm

Vacuum Pump Oil



- Designed for rotary vane vacuum pumps
- Maximises performance and increases depth of vacuum
- Contains additives to improve the anti wear performance, oxidation resistance, corrosion protection, pour point (cold starting), air release and anti foaming tendencies
- Low lacquer & carbon forming tendency ensuring cleaner systems
- Excellent corrosion resistance
- Improved sealing and mechanical efficiency
- High film strength. Minimal oil carry-over



Description	Part No.
Universal Oil 1 L	HV68/1
Universal Oil 4 L	HV68/4

Information correct at time of going to press. Not all products are available in all regions.



VG-64



JAV-1041

VG64

DUAL PORT DIGITAL VACUUM GAUGE



Dual port, high resolution, fast response digital vacuum gauge now with convenient magnetic HVAC strap.

- Reads vacuum in seven international units
- Ultra fine resolution
- Auto shut-off
- Display updates every 1/2 second
- Convenient built-in hanger
- Easy to clean sensor (use isopropyl alcohol)
- Low battery indicator

Description	Part No.
Digital Vacuum Gauge	VG-64

Digital Vacuum Gauge



Patented vacuum gauge technology* enables the highest accuracy possible in a micron gauge.

- Small and mighty. Pocket size, measuring only 110mm tall
- Automatic oil sensor
- 'Calibration self-check' function tells the user when and if re-calibration is necessary
- Instantaneous warm-up and response time
- 'Leak Rate Indicator' & 'Programmable Productivity' functions (Evacuation and Rise-Time Analysis) – saving you time by automating the work

Description	Part No.
Digital Vacuum Gauge	JAV-1041

Information correct at time of going to press. Not all products are available in all regions.



Digital Alarm Thermometer



- Max/min memory
- Stainless Steel probe 5" with 1 metre cable
- Hold and alarm functions
- Hand size, with detachable probe
- Batteries included

Description	Part No.
Digital alarm thermometer	RT-905
Units	°C, °F
Temperature range	-50 ~ 200°C / -58 ~ 392°F
Power	1 X AAA (included)
Probe size	230 mm
Dimensions	118 mm

Information correct at time of going to press. Not all products are available in all regions.



Hydrocarbon Scale

(INC. TWO HOSES AND BALL VALVE)



- Large weighing platform and durable and sturdy injected molded components
- Back-lit LCD display
- High accuracy load cell
- Pass-through charging (moving the charge hose does not affect weight)
- Small diameter durable CLRF Series hoses included
- Charging valve included for precision charging
- Schrader valves included to prevent refrigerant loss/leaks
- Cylinder adapter with Secure Seal low-loss fitting included for inverted charging
- 2 charging orientation options: upright and inverted
- Velcro loop included for stabilizing the refrigerant canister (upright charging)
- Designed for R600a and R290
- Other charging methods are possible by using additional adapters for different canister types

Description	Part No.
Hydrocarbon scale	DS-5000
Capacity (g/oz)	5000g/176oz
Accurac (g/oz)	1g / 0.1oz
Power Supply	2 x AA batteries (included)
Dimensions l x w x h	200 x 150 x 48mm (7.9 x 5.9 x 1.9")

Hydrocarbon Can Valve



- Can valve connection 1/4" SAE outlet
- Suitability R600 and R290 cans



Description	Part No.
Hydrocarbon Can Valve	JAV-1393

Information correct at time of going to press. Not all products are available in all regions.



Procharge 100

REFRIGERANT CHARGING SCALE



The Procharge 100 digital refrigerant charging scale is a welcome addition to JAVAC's range of refrigerant service tools. An upgrade on the current best selling Procharge unit.

- Ideal for air conditioning and refrigeration
- This unit is highly accurate with 5 gram resolution and an increased weighing capacity of 100kg. The compact platform is 223mm x 223mm, easily removed from the carry case for use, also featuring an easy to read LCD display
- This unit also includes a memory function, holding the last reading until cleared. Even when the unit automatically shuts down after 10 minutes of non use, the last reading is still stored in memory

Type	Digital
Weighing capacity	100kg
Accuracy	+/- 0.5%
Resolution	5 g
Power	9 V battery
Battery life	30 hours
Operating temperature	10 to 40°C
Weight	2.5kg
Dimensions	250 x 250mm

Description	Part No.
Procharge 100	G58610

Information correct at time of going to press. Not all products are available in all regions.



Nitrogen Regulator 50 Bar (OFN)



- 300 bar maximum inlet pressure.
- 0 - 50 bar (0 - 750 psi) outlet pressure range.
- Suitable for testing systems using R410A and all standard refrigerants, in accordance with BS EN 378.
- 1/4" SAE flare outlet connection to allow for rapid connection to industry standard hoses.
- Large pressure adjustment knob to allow for easy pressure adjustment.

Description	Part No.
Nitrogen Regulator 50 Bar (OFN)	RS-750
Max. inlet pressure	300 bar
Outlet pressure range	0 - 50 bar (0 - 750 psi)
Connector type	1/4" outlet flare connection

Information correct at time of going to press. Not all products are available in all regions.



Nitrogen Rig

PRESSURE TESTING RIG WITH ISOLATION VALVE AND GAUGE



A complete testing rig specifically designed for high pressure testing in HVAC/R systems using R410A.

- Designed for testing refrigeration systems that use R410A (in accordance with BS EN 378).
- 1/4" SAE flare outlet connection to allow for rapid connection to industry standard hoses.
- Safety relief valve to prevent regulator over-pressurisation.
- Robust rig that is ideally suited to the rigours of daily use.

Description	Part No.
Nitrogen Pressure Testing Rig	RS-750-RIG

Information correct at time of going to press. Not all products are available in all regions.



Nitrogen Purge Tool



When performing repairs on refrigeration or air conditioning piping, it is important to purge the inside of the pipe with nitrogen to prevent oxidation in the joint area, both before and during the brazing process.

This tool allows you to initiate the PURGE function at a pre-set regulated flow rate. Then, with a simple turn of the control knob, you can switch to the BRAZE function, which adjusts the flow rate to a level ideal for the brazing process.

This feature helps minimize nitrogen usage while also preventing air from entering the system during the repair.

The tool is designed to attach to a standard nitrogen regulator and comes equipped with a 1/4" SAE flare outlet connection, which is compatible with standard HVAC hoses.

Materials of construction	Body: Aluminum Inlet, outlet and internals: Brass
Gas service	Nitrogen (N ₂)
Maximum working pressure	(as indicated on device)
Outlet Flow Rate	3 L/min (during brazing mode)
Operating temperature	-20°C to +50°C
Weight (kg)	0.110
Dimensions (W,L,D)	38 x 80 x 30 mm
Outlet	1/4" SAE

Description	Part No.
Nitrogen Purge Tool	JAV-1444
Nitrogen Regulator RS-750	RS-750

Information correct at time of going to press. Not all products are available in all regions.

Access Valves & Core Tools



Description	Part No.
Valve core removal tool	S-209
Schrader Valve 1/4"	SU-04
Schrader Valve 5/16" – R410A	SU-05

Ball Valves & Adaptors



Description	Part No.
Ball Valve R410A 5/16", 1/4 turn	EL33023
Set of 3 Ball Valves (RBY) 1/4" SAE	EL33021
1/4" female flare x 1/4" male flare auto shut off	EL30035
Adaptor 5/16 to 1/4 for R410A	EL30036

10kg Cylinder Adaptor



Description	Part No.
10KG Cylinder Adaptor L/H R32	JAV-CA04218



04 BRAZING & WELDING

Brazing & Welding Kits	90
Brazing & Welding Torches	91-93
Heat Blockers & Accessories	94



ASPEN
PUMPS
GROUP



Oxy-acetylene Brazing & Welding Tool Kit

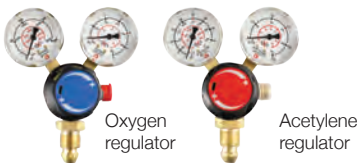

Description	Part No.
Tool kit	F23220001

Kit includes:

Oxygen Regulator x 1, Acetylene Regulator x 1, Brazing Torch and Mixer x 1, Pair of 5 m Hoses x 1, Flip Up Brazing Goggles x 1, Lightweight Nozzles (Assorted Sizes) x 1, Pistol Grip Spark Lighter x 1, Cylinder Spanner x 1, Multi Head Spanner x 1, Nozzle Cleaning Set x 1, Pair Of Flashback Arrestors x 1

Bottle Trolley



Description	Part No.
Oxygen and Acetylene Bottle Trolley 5 & 10L	9431380

Information correct at time of going to press. Not all products are available in all regions.



Olympus

BRAZING & WELDING TORCH



- Stainless steel nozzle
- Trigger start
- Variable flame control
- 360° swivel tip
- For use with MAPP and Propane gas

Description	Part No.
Olympus	OLY2

S2 Brazing Rods



- Premium grade S2 self-fluxing solder copper phosphorus alloy brazing rods
- Suitability copper-copper and high copper content alloys
- Melting range Solidus - 645°C, Liquidus - 850°C
- 1kg Pack. 500mm long
- Made in the UK

Description	Part No.
Brazing Rods	JAV-S2



Information correct at time of going to press. Not all products are available in all regions.



Fusion Dual

BRAZING & WELDING TORCH



- Stainless steel nozzle
- Manual ignition
- Double barrel
- Variable control swirl flame
- For use with MAPP & Propane Gas
- High temperature, faster brazing
- 360° Swivel Tip

Description	Part No.
Fusion Dual	FD-2

Bottle Trolley



Description	Part No.
Oxygen and Acetylene Bottle Trolley 5 & 10L	9431380

Information correct at time of going to press. Not all products are available in all regions.

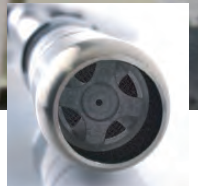

Flexi Torch

BRAZING & WELDING TORCH



- Trigger start ignition
- Flexible 205mm stainless steel burner tube
- Access hard to reach places
- Tube stays cool throughout use
- Swirl flame
- For use with MAPP & Propane
- 800 – 1300°C



Description	Part No.
Flexi Torch	JAV-1104

Information correct at time of going to press. Not all products are available in all regions.



Heat Shield

HEAT BLOCKING COMPOUND



A reusable putty designed to protect sensitive parts from heat damage during brazing, soldering and welding. No more need for messy wet rags!

- Apply, remove and reuse - up to 40 times!
- Handy colour changing putty shows you when you need to replace the pot.

Description (Boxes of 12)

Heat Shield – EN

Each tub: net weight 325g, 92 x 67mm

Part No.

JAV-1002

PyroCool®

FLAME RETARDANT GEL

Advanced



Ready to use



Aerosol



Concentrate



Condensate pump safe

- Protects all surfaces and parts close to brazing, soldering and welding
- Reduces risk of fire by protecting surfaces and dissipating heat
- Suitable for copper, steel and aluminium pipework

Part No.	Product	Qty	Box Qty	Size
S050021GB	PyroCool	1	8	500ml
S050004GB	PyroCool	1	8	1L



Information correct at time of going to press. Not all products are available in all regions.

05

LEAK DETECTION

Refrigerant	96-97
Sprays	98
Ultra Violet	99-102

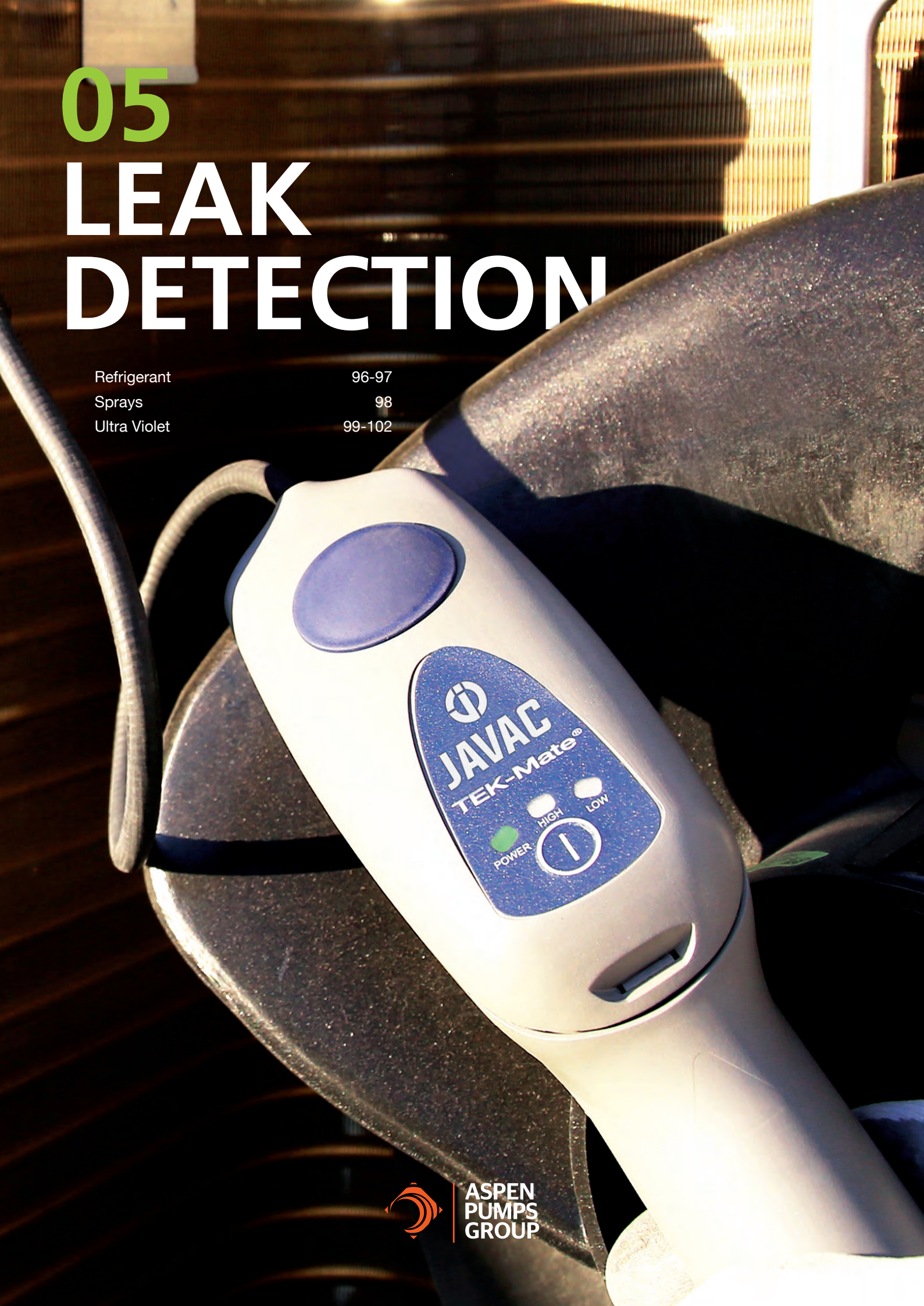

ASPEN
PUMPS
GROUP

05

LEAK DETECTION

REFRIGERANT



JAV-1283

D-Tek 3[®]

REFRIGERANT GAS LEAK DETECTOR



Detects all HCFCs, HFCs, HFOs, blends (including A2Ls), ammonia & SF6.

- Ultra high sensitivity to all standard refrigerant gases, 1gm/yr
- Compatible with optional CO2 sensor and flammable refrigerant sensor
- Longest sensor life in the industry

Description	Part No.
D-Tek 3 Leak detector	JAV-1283 (721-202-G1)

Suggested spare	Part No.
TEK-Check [®] reference leak	703-080-G10

Verifies the functionality of your leak detector. R134A reference leak. 5g of refrigerant. Leak rate 5-9 grams per year at 20 Deg C. Easy to store.



718-202-G21

Gas-Mate[®]

HYDROCARBON & TRACE-A-GAS[™] COMPATIBLE



- Twice as sensitive as the nearest competitor
- Trace-A-Gas[™] sensitivity hydrogen 5 grams a year
- Also detects natural gas, propane, butane, cyclopentane, ethane, ethanol, isobutane and ammonia – R1234YF, R1234ZE, R32, R290, R600
- A2L & A3 ready
- Adjustable sensitivity helps pinpoint leaks fast
- Auto-zeroing for ignoring background gas levels in leak test area.
- Certified intrinsically safe by MET Laboratories for use in combustible / explosive environments

Description	Part No.
Gas-Mate	718-202-G21

Suggested spares	Part No.
Sensor	706-700-G1

Information correct at time of going to press. Not all products are available in all regions.

05

LEAK DETECTION

REFRIGERANT



705-202-G21

Tek Mate®

REFRIGERANT GAS LEAK DETECTOR



- F-GAS Compliant, tested to BS EN 14624.
- Controls soft touch switch-off, low sensitivity, high sensitivity.
- Contamination adjustment – automatic.
- R22: 2g / yr.

Description	Part No.
TEK-Mate	705-202-G21

Suggested spares	Part No.
Filter for TEK-Mate	705-600-G1
Spare sensor for TEK-Mate	703-020-G1



724-202-G21

D-Tek Stratus®

REFRIGERANT GAS LEAK DETECTOR



- 4-point sensitivity settings in pinpoint mode (super, high, medium & low)
- New lithium ion battery with quick charge capability and easy field replacement
- Manual zero mode allows the engineer to zero the detector to background refrigerants
- Comes with an additional extra long probe for hard to reach areas, and multiple-region charging adaptors
- Probe filter (pre installed) can be easily checked and replaced, and redesigned infrared sensor has the longest life in the industry
- Detects all CFCs, HCFCs, HFCs, and HFOs
- Designed for ergonomic comfort with rugged carrying case and comes with a two-year replacement warranty

Description	Part No.
D-TEK Stratus (inc.case)	724-202-G11

Information correct at time of going to press. Not all products are available in all regions.

RTU[®] BU

BUBBLE-UP LEAK DETECTOR



Ready to use



Aerosol



Concentrate



Condensate pump safe

- Specifically designed for refrigerant leaks
- Produces long-lasting bubbles
- Clings to all surfaces

Part No.	Product	Qty	Size
S010173GB	RTU BU	8	1L

Hazardous transport.



EasyFind[®]

BUBBLE-UP LEAK DETECTOR



Ready to use



Aerosol



Concentrate



Condensate pump safe

- Specifically designed for refrigerant leaks
- Produces long-lasting bubbles
- Clings to all surfaces

Part No.	Product	Qty	Size
S010350GB	EasyFind	12	400ml

Hazardous transport.



05

LEAK DETECTION

ULTRA VIOLET

Injection



JAV-1421

Glo Seal™

UV DYE & SEALANT – INJECTION



Works to pinpoint the exact location of all leak areas and seals AC&R micro-leaks from the inside.

The Spectroline patented dual pivoting adapter easily switches from 5/16" or 1/4" flare fittings, making it a versatile tool to keep on hand.

- Works with all popular refrigerants and oils
- Non-polymer, oil-soluble formula safe for system components and recovery equipment
- Remains safely in system to help protect against future leaks highly concentrated to see all leaks glowing brightly



JAV-1420

Description	Part No.
Glo Seal™ 10ml Syringe Injector – Single Use	JAV-1421
Glo Seal™ 10ml Syringe Injector & Adapter	JAV-1420

Kit includes:
 2 x Single use syringe injector (10 ml)
 1 x Patented dual adapter (1/4" flare - 5/16" flare)

Dosage	Treats (cooling)
10ml	0.5 - 2.5 tons of cooling (1.76 - 8.79 kW)

Information correct at time of going to press. Not all products are available in all regions.

05

LEAK DETECTION

ULTRA VIOLET

Injection



Inject dye with a turn of the handle.

JAV-1103

Cool Seal™

AC LEAK SEALANT – INJECTION



Seals micro leaks in condensers, evaporators, o-rings and hoses

- Can add years to older, out-of-warranty AC&R systems that leak small amounts of refrigerant
- Works with all popular refrigerants and oils
- Remains safely in system to help protect against future leaks



JAV-1106



JAV-1103

Dosage	Treats (cooling)
15ml	up to 14kW
60 ml	up to 56kW

Description	Part No.
Cool Seal, 1 x 15ml (CS-1CS)	JAV-1103
Cool Seal Kit (CS-100CS)	JAV-1106

Kit includes:
 2 x 15ml Cool Seal A/C leak sealer cartridges
 1 x Injector assembly
 1 x 20cm hose assembly with low-loss fitting & check valve
 1 x R-410A adapter; service labels

Information correct at time of going to press. Not all products are available in all regions.

Injection



JAV-1156 EZ-Ject Complete Kit



Inject dye with a turn of the handle.

EZ-Ject™

FLUORESCENT DYE LEAK DETECTION – INJECTION



The revolutionary way to add fluorescent dyes into air conditioning and refrigeration systems – without the use of additional refrigerant, manifold and additional hoses. No pouring and no refrigerant required for injection.

- Spectroline dyes glow brighter than the competition
- One calibrated cartridge provides exact dosing for multiple systems
- Easily overcomes system pressure up to 450 psi (31 bar)



JAV-1154



JAV-1155



JAV-1210EZ-25

Description	Part No.
EZ-Ject Complete Kit (SPE-HVLEZE) <i>Kit includes: 2 x 15ml EZ-Ject Universal/POE dye cartridge, 1 x Dye injector assembly, 1 x 20cm hose assembly with low-loss fitting & check valve, 1 x R-410A adapter; service labels, 1 x Violet light LED leak detection lamp, 1 x Fluorescence-enhancing glasses, 1 x 60ml Glo-Away Plus dye cleaner, 3 x Drip plugs; Service labels</i>	JAV-1156
EZ-Ject Kit (SPE-EZ100E-CS) <i>Kit includes: 2 x 15ml Universal/POE dye cartridge, 1 x Dye injector assembly, 1 x 20cm hose assembly with low-loss fitting & check valve</i>	JAV-1154
Universal/POE dye cartridge (SPE-EZ5E-CS)	JAV-1155
20cm hose assembly with low-loss fitting & check valve	JAV-1210

Dosage	Treats (lubricant / refrigerant)
15ml	up to 7.6L / Up to 11.3kg

Information correct at time of going to press. Not all products are available in all regions.

05

LEAK DETECTION

ULTRA VIOLET



Violet light LED FLUORESCENT LEAK DETECTION LAMP



Economical and powerful, cordless leak detection lamp. Reveals even the smallest refrigerant leaks! Universal/POE dyes only.

- Provides optimal fluorescent dye response and contrast
- Pre-focused beam optimizes fluorescent response
- Compact design easily gets into tight, cramped spaces
- Rugged, corrosion-resistant anodized lamp body delivers years of heavy use
- Anti-roll cuff

NOTE: For most applications, our violet light lamp does not require fluorescence enhancing glasses.



JAV-1176

Description	Part No.
Violet light LED leak detection lamp (SPE-HVL-CS)	JAV-1176
<i>Kit includes:</i>	
1 x Violet Light LED Leak Detection Lamp	
3 x AAA batteries	
1 x Fluorescence-enhancing glasses	

Sensitivity	up to 8m
Power	3 x AAA batteries (included)
Run time	up to 5hrs

Information correct at time of going to press. Not all products are available in all regions.



06 BRASS & COPPER FITTINGS



About C&D	104-105
Service Kits	106-108
Smartlock	109-110

C&D VALVE



For more than 20 years, we have engineered industry-leading fittings designed for reliability, durability, and long-term performance. Every product exceeds current standards and is built to withstand the most demanding applications.

Our unmatched warranty is supported by comprehensive technical expertise, helping customers identify root causes, resolve issues efficiently, and achieve better outcomes for all stakeholders. We stand firmly behind our fittings as the best-engineered solution available.

With a comprehensive product range, strong local stock availability, and the fast, dependable delivery Aspen is known for, C&D fittings are the smart, trusted choice for professionals who refuse to compromise. Proven in the toughest environments for over two decades, they deliver performance you can rely on.

Developed by the experts at Sky Refrigeration Limited, these fittings were engineered in Australia - home to some of the harshest refrigeration conditions in the world - ensuring exceptional durability, performance, and reliability in any environment.

Now part of the Aspen Pumps Group, Sky's 20-year legacy of innovation and quality continues, exclusively available across the UK and EU under the C&D brand.

This catalogue provides a comprehensive overview of each fitting, highlighting key features and benefits to give you the knowledge and confidence to sell effectively.

Trusted quality in every connection.

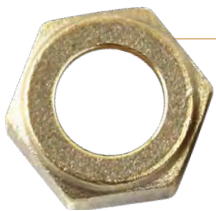

Scan here
for full range:



2026 Catalogue out now!



Information correct at time of going to press. Not all products are available in all regions.



Compliance you can count on

C&D Copper & Brass Fittings:

Choosing the right fittings for HVAC/R systems is essential, as high-quality, standards-compliant components have a direct impact on system performance, reliability, and lifespan. C&D copper and brass fittings are engineered and manufactured to meet the highest international standards, providing outstanding strength, precision, and durability. Specifically designed for HVAC/R applications, these fittings deliver secure connections, superior leak resistance, and long-term operational efficiency. Backed by advanced engineering and strict quality control, C&D fittings provide lasting performance and complete peace of mind.



Standards & Compliance:

At C&D, we understand that compliance is key to safety, reliability, and customer trust. That's why all of our fittings are tested and certified to meet or exceed the latest standards, including:

- **PED 2014/68/EU** – Pressure Equipment Directive
- **EN 12420 CW617N** – Hot-forged brass fittings
- **BS EN 1982:1999** – Machined brass fittings
- **ISO 5149.2** – Refrigerating systems and heat pumps safety requirements
- **EN 14585:2006** – Copper and copper alloy fittings
- **AS5149.2, EN1254-1, EN1254-5, EN14276, EN378-2** - Copper Iron Fittings
- **RoHS Directive** – Full compliance ensuring environmentally safe materials



C&D
VALVE

Information correct at time of going to press. Not all products are available in all regions.



Schrader Fittings Kit

Key Features

- Handy refillable case with the most commonly used fittings
- Dedicated kit for Schrader access fittings
- Refill packs available

Complete Kit Part No.	Kit Includes	Refill Pack Part No.	Qty per pack
CD-200-KIT-1	Schrader Union – 1/4" SCHR x 3 Steps 3/16" ID x 1/4" & 3/8" OD includes cap & core	CD-209-0403-3	x 5
	Schrader Union – 1/4" SCHR x 1/4" CU Tail includes tool, cap & core	CD-208-0404	x 5
	Schrader Union Assembly – 1/4" SCHR x 1/8" NPT incl. cap & core	CD-207-0402	x 5
	Schrader Union Assembly – 1/4" SCHR x 1/4" NPT incl. cap & core	CD-207-0404	x 5
	Schrader Union – 410A – 5/16" SCHR – 1/4" CU Tail incl. cap & core	CD-208-0504	x 2
	Schrader Swivel Tee (Brass) – 1/4" FSAE x 1/4" SCHR x 1/4" SCHR incl. cap & core	CD-213-040404	x 2
	Schraeder valve swivel branch 1/4" access T incl. cap & core	CD-214-040404D	x 2
	1/4" Flare Schrader cap no tool	CD-205-4	x 5
	Schrader Valve Core – 410A	CD-204-1	x 10



CD-209-0403-3



CD-208-0404



CD-207-0402



CD-207-0404



CD-208-0504



CD-213-040404



CD-214-040404D



CD-205-4



CD-204-1



Refill packs supplied in euro hook bags



Flare Nut Kit

- Handy refillable case with the most commonly used fittings
- Dedicated kit for flare nuts
- Refill packs available

Complete Kit Part No.	Kit Includes	Refill Pack Part No.	Qty per pack
CD-200-KIT-2	Flared Copper Washer 1/4"	CD-109-04	x 10
	Flared Copper Washer 3/8"	CD-109-06	x 10
	Flared Copper Washer 1/2"	CD-109-08	x 10
	Flared Copper Washer 5/8"	CD-109-10	x 10
	Flared Copper Washer 3/4"	CD-109-12	x 10
	Flare Nut Short Barrel 1/4" FSAE	CD-201-0404	x 10
	Short Barrel Brass Flare Nut - 5/16" FSAE	CD-201-0505	x 10
	Short Barrel Brass Flare Nut - 3/8" FSAE	CD-201-0606	x 10
	Short Barrel Brass Flare Nut - 1/2" FSAE	CD-201-0808	x 6
	Short Barrel Brass Flare Nut - 5/8" FSAE	CD-201-1010	x 2
	Short Barrel Brass Flare Nut - 3/4" FSAE	CD-201-1212	x 2
	Forged Reducing Flare Nut - 3/8" FSAE x 1/4"	CD-201-0604	x 4



CD-109-04



CD-109-06



CD-109-08



CD-109-10



CD-109-12



CD-201-0404



CD-201-0505



CD-201-0606



CD-201-0808



CD-201-1010



CD-201-1212



CD-201-0604



Refill packs supplied in euro hook bags

Co2 130 Bar Brass & Schrader Kit



- Handy refillable case with the most commonly used fittings.
- Dedicated kit for Schrader access fittings and 130 bar CO2
- Refill packs available

Complete Kit Part No.	Kit Includes	Refill Pack Part No.	Qty per pack
CD-200-KIT-3	Schrader core 130 bar	CD-204-1-HP	x 10
	1/4" SAE Cap 130 bar	CD-275-04	x 10
	3/8" SAE Cap 130 bar	CD-275-06	x 5
	Schrader Union Assy- 1/4 SCHR x 1/8 NPT incl. cap & core 130 bar	CD-207-0402-HP	x 5
	Schrader Union Assy - 1/4 SCHR x 1/4 NPT incl. cap & core 130 bar	CD-207-0404-HP	x 5
	Schrader Union - 1/4 SCHR x 3 Steps 3/16 ID x 1/4 & 3/8 OD incl. cap & core 130 bar	CD-209-0403-3-HP	x 5
	Schrader Union 1/4 Schr (1/4 ID spigot) 130 bar	CD-209-0404-HP	x 5
	Schrader Union 1/4 Schr (3/8 ID spigot) 130 bar	CD-209-0406-HP	x 5
	1/4 Schrader x 1/4 SCH x 1/4 FSAE fixed 130 bar	CD-215-040404-XHP	x 4
	1/4MSAE x 3/8 ID solder 130 bar	CD-218-0406	x 4
	Flared Copper Washer 1/4"	CD-109-04	x 10



CD-204-1-HP



CD-275-04



CD-275-06



CD-207-0402-HP



CD-207-0404-HP



CD-209-0403-3-HP



CD-209-0404-HP



CD-209-0406-HP



CD-215-040404-XHP



CD-218-0406



CD-109-04



Refill packs supplied in euro hook bags

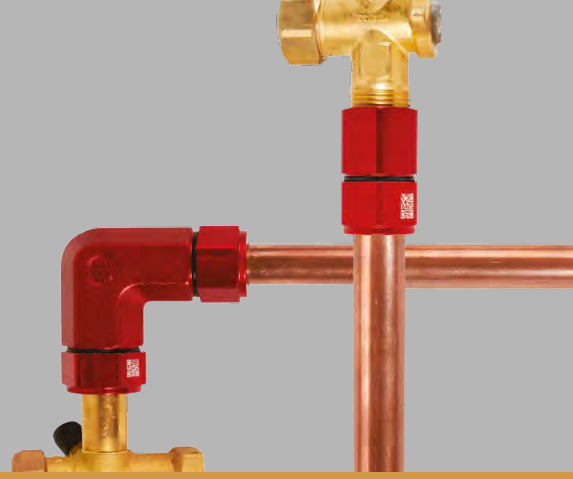

Smartlock

HVAC/R Compression Fitting for all refrigerant lines.

- Positioning strip aligns all components for easy insertion of tube
- Compatible with all refrigerants
- No limit on pressure and temperature range due to metal to metal sealing technology
- Over torque prevention design

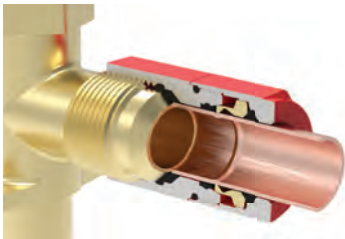

Metal to Metal Seal Technology

- ✓ Vibration dampening
- ✓ Permanent solution
- ✓ 10 year warranty

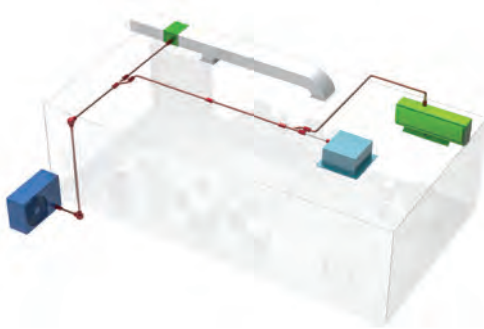

TECHNICAL SPECIFICATIONS

Materials of construction	Aluminium alloy
Compatible with	ALL refrigerants
Wide temperature range	-40°C to 150°C
Compatible tube materials	Copper tube (hard & soft) Aluminium tubes

CU+CU



AL+CU



AL+AL



NO

**BRAZING | FLARING | WELDING
FIRE HAZARD | HOT WORK PERMIT
SPECIAL GAUGE | SPECIAL TOOL
OXIDATION | NITRO PURGING**

ONE SIMPLE SOLUTION



High Pressure Range

SIZE	DESIGN PRESSURE	BURST PRESSURE
1/4"	1700psi	9700psi
3/8"	1600psi	8500psi
1/2"	1300psi	8000psi
5/8"	1300psi	6800psi
3/4"	1000psi	5100psi
7/8"	960psi	4800psi



Information correct at time of going to press. Not all products are available in all regions.

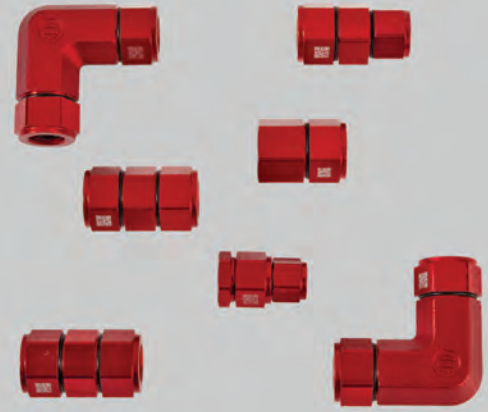

Smartlock

Flare Connector Multi Angle

Size	Part no.
1/4"	FCMA1400
3/8"	FCMA3800
1/2"	FCMA1200
5/8"	FCMA5800
3/4"	FCMA3400



Union Straight

Size	Part no.
1/4"	UNST1400
3/8"	UNST3800
1/2"	UNST1200
5/8"	UNST5800
3/4"	UNST3400
7/8"	UNST7800



Flare Connector Reducer

Size	Part no.
1/2" - 3/8"	FCRS1238



Union Reducer

Size	Part no.
3/8" - 1/4"	UNRD3814
1/2" - 3/8"	UNRD1238
5/8" - 1/2"	UNRD5812
3/4" - 5/8"	UNRD3458
7/8" - 3/4"	UNRD7834



Swage Union

Size	Part no.
3/8"	SWUN3800
5/8"	SWUN5800
3/4"	SWUN3400
7/8"	SWUN7800



Elbow Union

Size	Part no.
1/2"	ELUN1200
5/8"	ELUN5800
3/4"	ELUN3400
7/8"	ELUN7800



Elbow Swage Union

Size	Part no.
3/8"	ELSW3800
5/8"	ELSW5800
3/4"	ELSW3400
7/8"	ELSW7800



07 SUPPORT & MOUNTING

Rubber Feet	112-115
PVC Mounting Blocks	116
Support Feet	117-119
Heat Pump Kit	120
Metal Frames	123-126
Wall Brackets	127-135
Roof Brackets	136
Anti-Vibration Dampers	137-139
Anti vibration pads & strips	140
Trays	141
Accessories	142



ASPEN
PUMPS
GROUP

07

SUPPORT & MOUNTING

RUBBER FEET

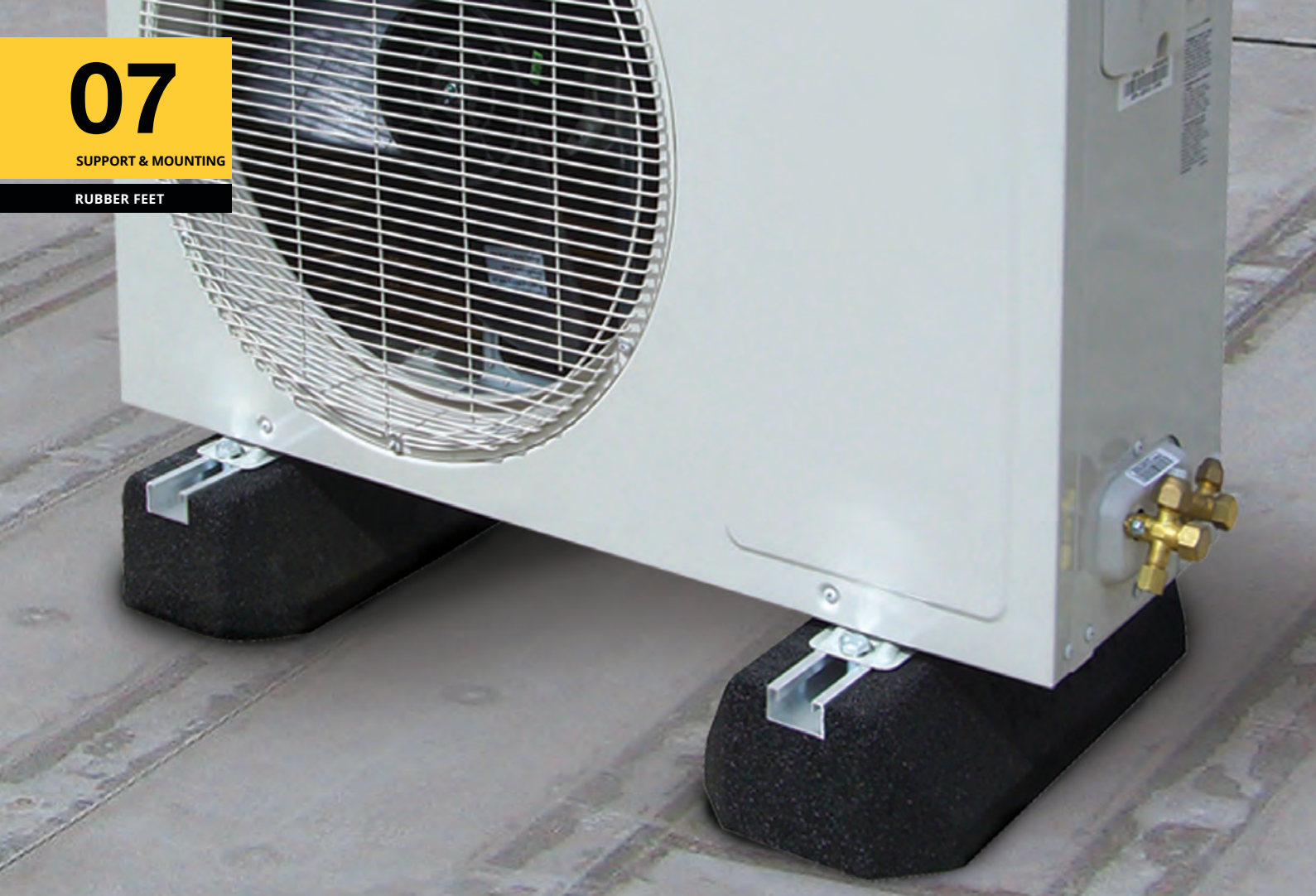

Premium Fix-It Foot

The neat and tidy rubber Fix-it Foot is simple, durable and comes in a variety of sizes. Extra clearance can be created using a High Bloc which fits underneath. Strapped per pair, and including bolt set.



KEY FEATURES ↓

- ✓ Quick and easy installation
- ✓ Durable recycled rubber reduces vibration and adds stability.
- ✓ Aluminium channel firmly anchored at the top for easy attachment of services.
- ✓ Rail size 40x21mm

Product Code	Size	Profile (mm)	Height (mm)	Width (mm)	Weight (Kg)	Max. Load (Kg)	Pallet Qty
B0084	250	40	95	180	2.4	82	68
B0085	400	40	95	180	3.5	128	60
B0386	600	40	95	180	5.8	224	40
B0134	1000	40	95	180	9.9	295	28



The neat and tidy rubber Fix-it Foot is simple, durable and comes in a variety of sizes. Extra clearance can be created using a High Bloc which fits underneath.

Information correct at time of going to press. Not all products are available in all regions.

07

SUPPORT & MOUNTING

RUBBER FEET



Fix-it Foot & High Bloc

The neat and tidy rubber Fix-it Foot is simple, durable and comes in a variety of sizes. Extra clearance can be created using a High Bloc which fits underneath.



KEY FEATURES ↓

- ✓ Quick and simple install.
- ✓ Aluminium channel securely anchored in top for easy fixing of services.
- ✓ Wide range of height and length options available.
- ✓ Durable recycled rubber reduces vibration and adds stability.

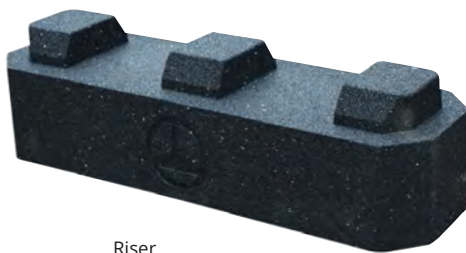

Riser



Fix-it Foot

Description	Product Code	Length (mm)	Width (mm)	Height (mm)	Weight (Kg)	Max. Load (Kg)
250	B6735	250	180	95	2.4	82
400	B6736	400	180	95	3.5	128
600	B6737	600	180	95	5.8	224
1000	B9096	1000	180	95	9.9	295
250 Low	B9043	250	130	50	1.3	82
400 Low	B9045	400	130	50	2.1	128
500 Low	B9368	500	130	50	2.5	134
600 High Bloc	B6974	600	180	120	10.2	224
1000 High Bloc	B6973	1000	180	120	17.7	295

Information correct at time of going to press. Not all products are available in all regions.

Optima Slim Fix-It Foot

KEY FEATURES ↓

- ✓ Quick and simple install.
- ✓ Aluminium channel securely anchored in top for easy fixing of services.
- ✓ Durable recycled rubber reduces vibration and adds stability.
- ✓ Rail available in two sizes: 40x21mm or 20x15mm



The neat and tidy rubber Fix-it Foot is simple, durable and comes in a variety of sizes. Strapped per pair, and including bolt set.

Product Code	Size	Profile (mm)	Height (mm)	Width (mm)	Weight (Kg)	Max. Load (Kg)	Pallet Qty
B0085-S20	400	20	95	135	5.7	180	90
B0386-S20	600	20	95	135	8.5	300	66
B0134-S20	1000	20	95	135	13.8	350	48
B0085-S40	400	40	95	135	5.5	160	90
B0386-S40	600	40	95	135	8	265	66
B0134-S40	1000	40	95	135	13	310	48

07

SUPPORT & MOUNTING

PVC MOUNTING

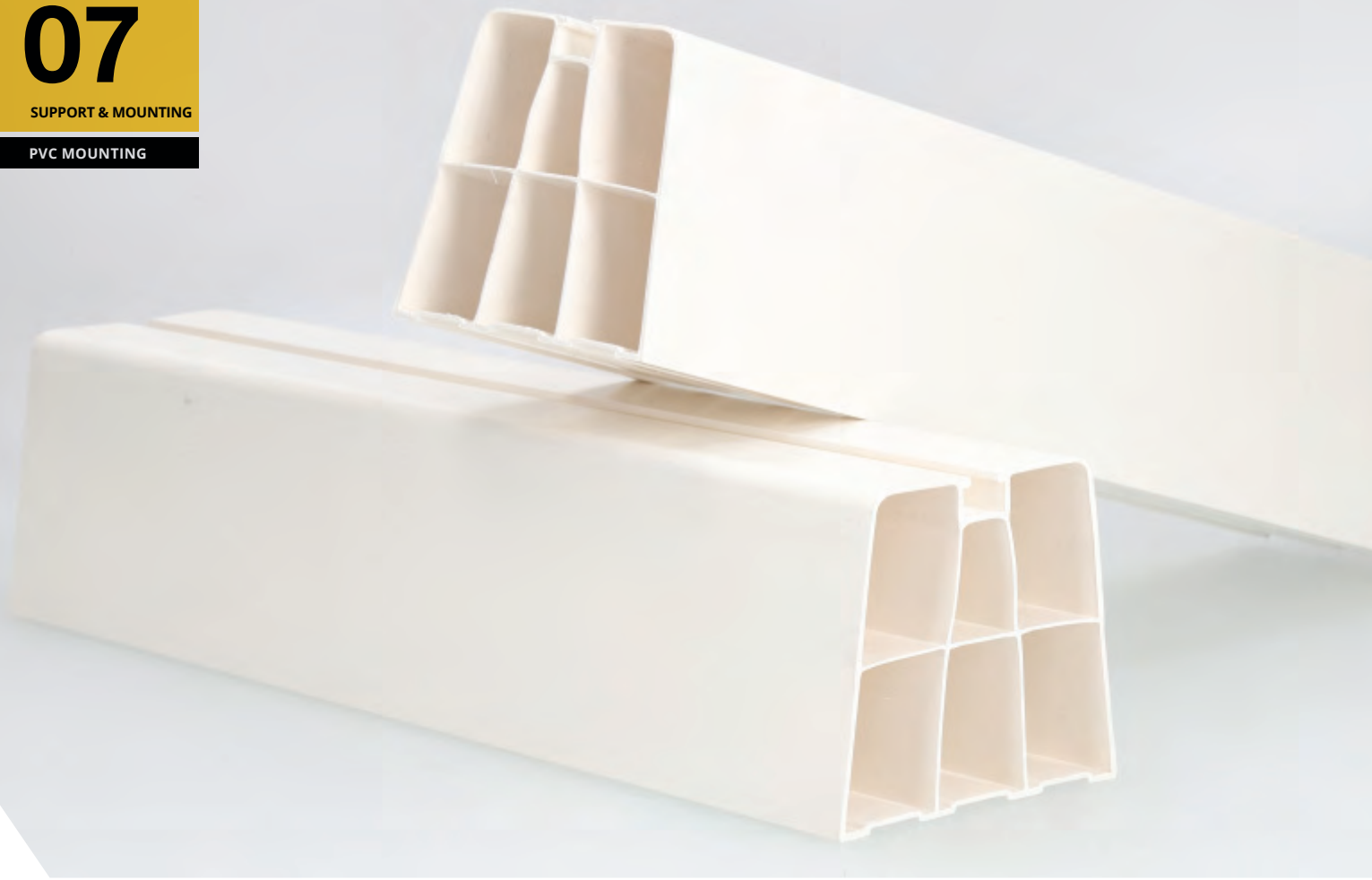

CONDENSER GROUND BLOCKS

Floor bases made of rigid PVC.

Item code	Dimensions LxH	Max. Load
P-032-01	350 x 80 mm	140 kg
P-031-01	450 x 80 mm	140 kg
P-030-01	1000 x 80 mm	140 kg

ECO FLOOR BASE

Made of shockproof, UV-resistant plastic, equipped with screws and bolts for fixing to the outdoor unit and adhesive strips for a good fit to the floor.

Part No.	Dimensions	Max. Load
9898-033-01	L 420 mm	320 kg

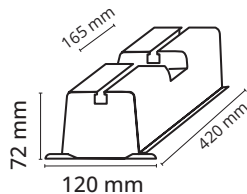



Information correct at time of going to press. Not all products are available in all regions.

COEXTRUDED PVC

UV resistant, with soft PVC base. They allow for secure adaptability to the ground, absorbing vibrations from the outdoor unit. Supplied with screws and bolts for securing the machine.

H 80

Part No.		Dimensions	Max. Load
9898-032-	<input checked="" type="checkbox"/>	L 350 mm	380 kg
9898-031-	<input checked="" type="checkbox"/>	L 450 mm	380 kg
9898-030-	<input checked="" type="checkbox"/>	L 1000 mm	380 kg

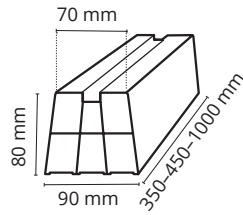

Part No.	Colour / RAL	
08	<input type="checkbox"/>	9010
95	<input checked="" type="checkbox"/>	9011



H 100

Part No.		Dimensions	Max. Load
9898-037-	<input checked="" type="checkbox"/>	L 350 mm	380 kg
9898-036-	<input checked="" type="checkbox"/>	L 450 mm	380 kg
9898-035-	<input checked="" type="checkbox"/>	L 1000 mm	380 kg

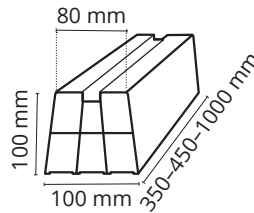

Part No.	Colour / RAL	
08	<input type="checkbox"/>	9010
95	<input checked="" type="checkbox"/>	9011



CLOSING CAP FOR PVC BASES H 80 MM

Part No.		Dimensions	
9898-029-	<input checked="" type="checkbox"/>	90x80	



CLOSING CAP FOR PVC BASES H 100 MM

Part No.			
9898-039-	<input checked="" type="checkbox"/>	100x100	



Part No.	Colour / RAL	
08	<input type="checkbox"/>	9010
95	<input checked="" type="checkbox"/>	9011



Information correct at time of going to press. Not all products are available in all regions.

07

SUPPORT & MOUNTING

SUPPORT FEET



NEW
ENHANCED GRIP

IMPROVED WIND
RESISTANCE

H Tech Set 330 & 400mm

Fabricated on site – and accepting a range of strut & box section sizes – the H Tech set is the most flexible choice on the market.



KEY FEATURES ↓

- ✓ 50% Higher Coefficient of Friction; better surface to surface grip than rubber feet
- ✓ Maximum stability; EPDM mat conforms better to uneven surfaces than rubber
- ✓ Optimum weight distribution over whole foot print
- ✓ Fits 41 × 41mm strut, 40 × 38mm, 21 × 41mm (H Tech 330mm only)
- ✓ Strut fittings & bolts included
- ✓ 100% recycled glass filled nylon foot construction
- ✓ Optional angled mat accessory for use on uneven ground

Description	Product Code	Foot Size (mm)	Weight (Kg)	Max. Load (Kg)
330mm Set (paired Foot)	B6088/B	330	2.63	300
H Tech 330mm (single Foot)	B6997/B	330	1.1	150
Angled Base 330mm 2.5° (single Foot)	B6098	330	0.6	150
400mm Set (paired Foot)	B6089	400	4.57	500
Angled Base 400mm 2.5° (single Foot)	BN7105	400	1.2	250



* Please note: Strut is not included in kit, and is shown as an example

ALL IN ONE BOX



KIT INCLUDES ↓

Foot with adhered mat	× 2
Bracket & fixings	× 1

Information correct at time of going to press. Not all products are available in all regions.

07

SUPPORT & MOUNTING

SUPPORT FEET



Multi Foot

Multi Foot is a multi-purpose support for cable tray or pipe. Used with channel, strut or threaded rod, this simple nylon foot is both versatile and economical.



KEY FEATURES ↓

- ✓ Quick and easy install.
- ✓ Available in 2 sizes.
- ✓ Rigid nylon foot.
- ✓ Versatile application using channel, strut or threaded rod.
- ✓ Accepts a full range of strut sizes.
- ✓ Adhered rubber mats provide additional roof protection.
- ✓ Boxed for convenience.



Description	Product Code	Length (mm)	Width (mm)	Height (mm)	Weight (Kg)	Max. Load (Kg)
400 mm – 4 Pack	B9640	400	180	80	6	259
600 mm – 3 Pack	B9655	600	220	80	11.7	474

ALL IN ONE BOX!



* Please note: Strut, channel & rod is not included, and is shown as an example

Information correct at time of going to press. Not all products are available in all regions.

07

SUPPORT & MOUNTING

HEAT PUMP KIT



Heat Pump Drip Tray

KEY FEATURES ↓

- ✓ Drip Tray, Feet and bracket pack all in one box kit
- ✓ Anti vibration Big Foot Fix-It feet 600 included
- ✓ Min 290 / max 340mm ground clearance for better airflow around heat pump
- ✓ High Bloc feet available as optional accessories to increase ground clearance
- ✓ Metal work in RAL9002 (white) RAL9005 (black)
- ✓ Made from 20/10 Galvanised Steel
- ✓ Polyester powder coated finish (approx. 100µm thickness)
- ✓ M8 8.8 zinc passivated carbon steel high strength fixings included

Description

Heat Pump Drip Tray Kit (white)

Heat Pump Drip Tray Kit (black)

Replacement metal tray with hook for brackets (white)

Product Code

B2075

B2076

S-096-71

Width (mm)

940

Height (mm)

Min. 290 /
Max. 340

-

Depth (mm)

420
(Drip Tray)
600 (Feet)

420

Working Load (Kg)

300

-

Max. Load (Kg)

300

-

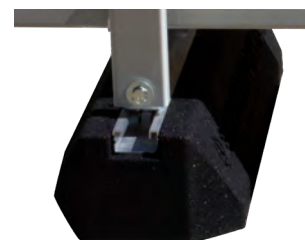
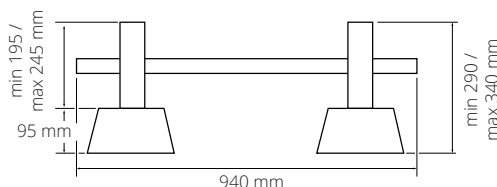
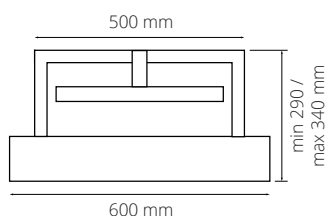

High-Bloc są dostępne jako akcesoria zapewniające większy prześwit.

- Szybka i łatwa instalacja



Information correct at time of going to press. Not all products are available in all regions.

07

SUPPORT & MOUNTING

FRAMES



Micro & Maxi Frames

The ideal choice for floor support of all types of condensing units, mini-splits, VRV/VRF and heat pumps.



ADVANTAGES ↓

- ✓ Suitable for all units.
- ✓ Adjustable length.
- ✓ Adjustable height.
- ✓ Maximum load up to 450 kg.

PROPERTIES ↓

- ✓ Galvanised frame.
- ✓ Powder coating in Black.
- ✓ Resistant to temperatures from -40 °C to +80 °C
- ✓ Quality assurance in accordance with ISO standards 9001 et ISO 14001.

OPTIONAL ↓

- (Sold separately)
- ✓ Vibration dampers for loads up to 450 kg.
 - ✓ Supports for Micro & Maxi bins.

Description

Micro Frame

Maxi Frame

Maxi Tray Support

Micro Tray Support

Reference

BN8410

BN8411

BN8412

BN8413



BN8410
Micro frame
Weight: 11.5 kg



BN8411
Maxi Frame
Weight: 16 kg

OPTIONNELS ↓



BN8412
Maxi Tray Support
Weight: 5.2 kg



9898-040
Support Anti Vibration
Weight: 0.4 kg



S-093-95
Maxi metal tray
1100 x 420 mm

S-097-95
Micro metal tray
850 x 390 mm

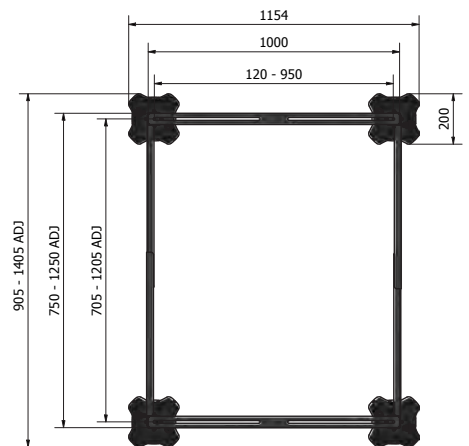
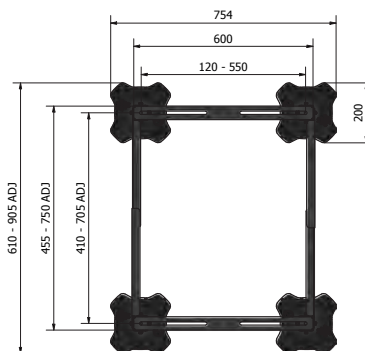

Information correct at time of going to press. Not all products are available in all regions.

07

SUPPORT & MOUNTING

FRAMES



Mini Frame & Extension Kit

For supporting small condensing units and heat pumps. Ideal for ground mounting or wind protected environments.



KEY FEATURES ↓

- ✓ Suitable for most mini splits & heat pumps
- ✓ Easy adjustment to suit any requirement
- ✓ Complete boxed kit of required components
- ✓ Install multiple units with extension kit

KIT INCLUDES ↓

Components	Frame	Ext.
200mm foot & mat	× 4	× 2
900mm End bar	× 2	× 1
700mm Cross bar	× 2	–
570mm Cross bar	–	× 2
Unit fixing kit	× 1	× 1

Description	Product Code	Box Length		Box Width		Box Height		Box Weight		Max. Load	
		(mm)	(in)	(mm)	(in)	(mm)	(in)	(Kg)	(lbs)	(Kg)	(lbs)
Mini Frame	BN8100	970	38 1/5	220	8 2/3	110	4 1/3	13	29	200	441
Mini Extension Kit	BN8101	970	38 1/5	220	8 2/3	110	4 1/3	8	18	200	441

Mini Frame BN8100 & Extension Kit BN8101

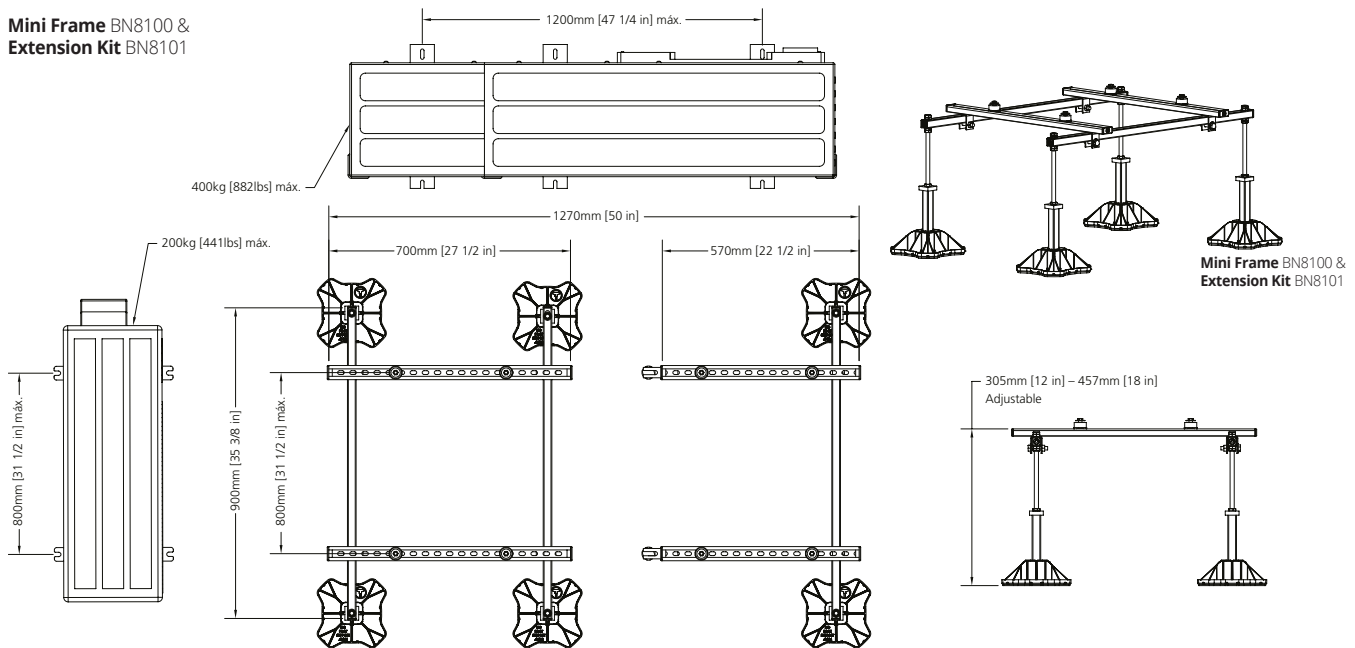

Information correct at time of going to press. Not all products are available in all regions.

07

SUPPORT & MOUNTING

FRAMES

NEW & IMPROVED

THE FRAME THAT EXTENDS IN ANY DIRECTION

Multi Frame Wide & Extension Kit

Multi Frame Wide is 1.2m long and 1.5m wide, providing superb frame stability and prevents overturning in higher wind applications.



KEY FEATURES ↓

- ✓ Suitable for larger units up to 1.5m width/depth
- ✓ Easy adjustment to suit any requirement
- ✓ Complete boxed kit of required components
- ✓ Install units back to back

KIT INCLUDES ↓

Multi Frame	Frame	Ext.
305mm foot & mat	× 4	× 2
1.2m End bar	× 2	× 2
1.5m Cross bar	× 3	× 3
Unit clamp kit (4 pack)	× 2	× 2
Connector	-	× 4

Part	Description	Product Code	Box Length		Box Width		Box Height		Box Weight		Max. Load	
			(mm)	(in)	(mm)	(in)	(mm)	(in)	(Kg)	(lbs)	(Kg)	(lbs)
1	Multi Frame Wide	BN6900	1600	62 7/8	350	13 7/8	150	6	52	115	500	1102
2	Wide Extension Kit	BN6901	1600	62 7/8	350	13 7/8	150	6	41	93	500	1102

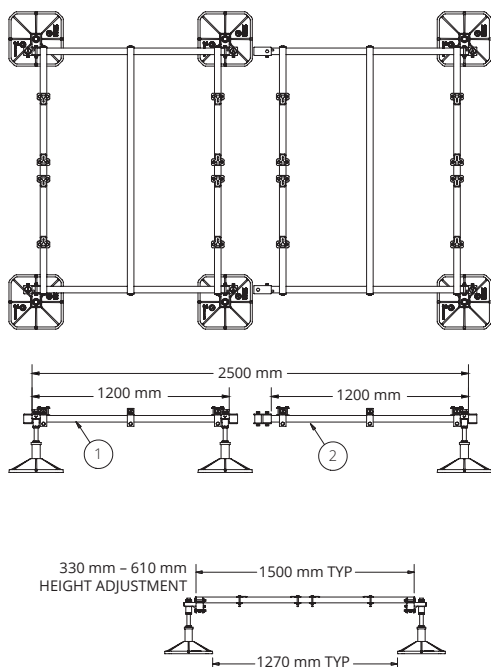

EASY TO ASSEMBLE
Cross bars simply place onto the end bars rather than sliding onto.



Information correct at time of going to press. Not all products are available in all regions.

07

SUPPORT & MOUNTING

FRAMES

NEW & IMPROVED

THE FRAME THAT EXTENDS IN ANY DIRECTION

Multi Frame & Multi Frame XL

Multi Frame and Multi Frame XL can be extended in any direction using the Extension kits, providing the flexibility to mix and match Multi Frame and Multi Frame XL to create the frame size and shape configuration to suit the install.



KEY FEATURES ↓

- ✓ 305mm Feet.
- ✓ 1m x 1.2m, 1.5m x 1.2m multiples.
- ✓ Mix and match any Multi Frame and Multi Frame XL of the same height.
- ✓ Extend from any side.
- ✓ Suits a wide variety of units.
- ✓ Adjustable leg assemblies.
- ✓ Easy to assemble - cross bars simply position onto the end bars.
- ✓ Supplied boxed with clamp kits.



KIT INCLUDES ↓

	FRAME	EXT.
Multi Frame		
305mm foot & adhered mat	x 4	x 2
1m End bar	x 2	x 2
1.2m Cross bar	x 2	x 2
Unit clamp kit (4 pack)	x 2	x 2
Connector	-	x 2
Multi Frame XL		
305mm foot & adhered mat	x 4	x 2
1.5m End bar	x 2	x 2
1.2m Cross bar	x 3	x 3
Unit clamp kit (4 pack)	x 2	x 2
Connector	-	x 2

Description	Product Code	Length (mm)	Width (mm)	Height (mm)	Weight (Kg)	Max. Load (Kg)
Multi Frame	BN9720	1000	1200	335 - 440	36	500
Extension Kit	BN9721	1000	1200	335 - 440	26	500
Multi Frame 560 mm	B9720/1	1000	1200	335 - 660	40	500
Extension Kit 560 mm	B9721/1	1000	1200	335 - 660	28	500
Multi Frame XL	BN9731	1500	1200	335 - 440	43	500
Extension Kit XL	BN9732	1500	1200	335 - 440	33	500
Multi Frame XL 560 mm	B9731/1	1500	1200	335 - 660	45	500
Extension Kit XL 560 mm	B9732/1	1500	1200	335 - 660	35	500

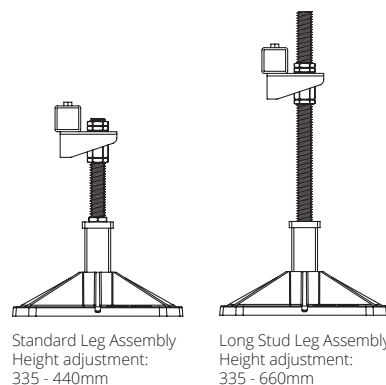

Information correct at time of going to press. Not all products are available in all regions.



SPLIT BRACKETS

STANDARD

SUPPLIED PRE-ASSEMBLED WITH DOUBLE M8 SCREWS FOR AN EASY INSTALLATION. HIGH RESISTANCE POWDER COATING.



GRINTA
slider for split bracket



Double M8 8.8
pre-assembled screws

P = Pre-assembled

Part No.	RAL	Dimensions WxHxL mm	Max. Load
S-491P	9002	450x400x800	160 kg
S-462P	9002	520x400x800	160 kg
S-463P	9002	560x400x800	160 kg
S-464P	9002	600x400x800	160 kg

07

SUPPORT & MOUNTING

BRACKETS



COLOUR



COLOUR



CERTIFIED
120-160 KG



CLOCK TYPE 2

ADJUSTABLE UNIVERSAL PRE-ASSEMBLED AND NON WALL BRACKETS WITH HOOK SYSTEM.



Part No.	RAL	Dimensions WxHxL mm	Max. Load
S-211P	9002	465x400x800	160 kg
S-213P	9002	550x400x800	160 kg
S-211P.95	9005	465x400x800	160 kg
S-213P.95	9005	550x400x800	160 kg

P = Pre-assembled

CLOCK TYPE 3

ADJUSTABLE UNIVERSAL PRE-ASSEMBLED AND NON WALL BRACKETS WITH HOOK SYSTEM.



Part No.	RAL	Dimensions WxHxL mm	Max. Load
S-310P	9002	420x400x800	120 kg
S-311P	9002	465x400x800	160 kg
S-313P	9002	550x400x800	160 kg
S-374-1P	9002	600x400x1000	160 kg

P = Pre-assembled



Information correct at time of going to press. Not all products are available in all regions.

07

SUPPORT & MOUNTING

BRACKETS

HEAVY DUTY SPECIAL

RAL 9002

kg

COLOUR

CERTIFIED 300-550 KG

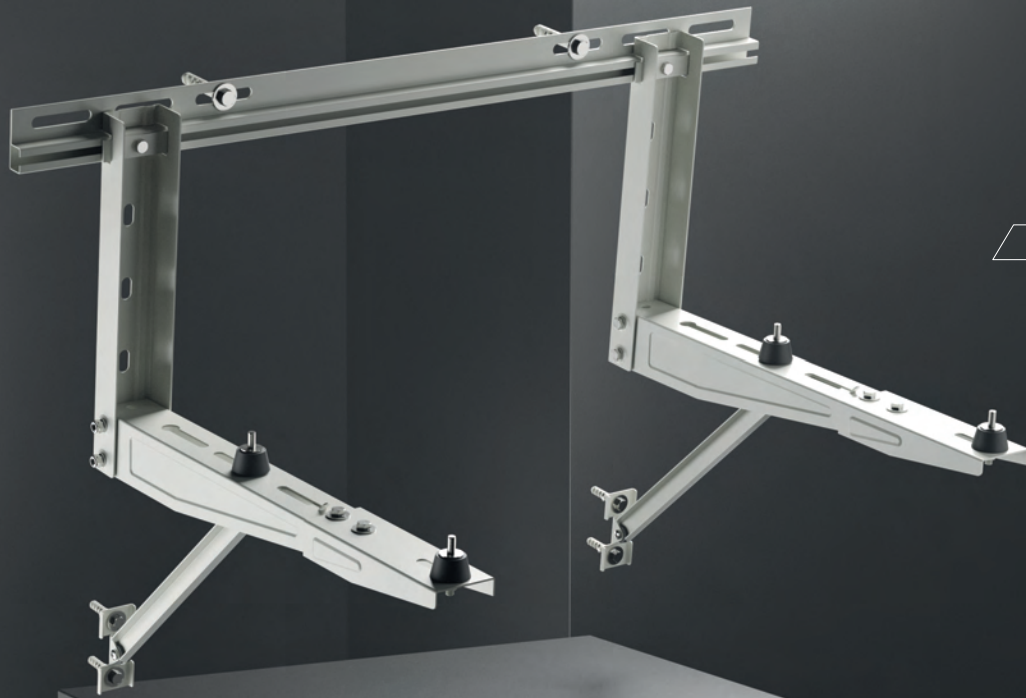

SUPER LOAD KIT*

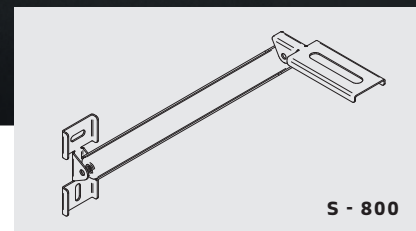

S - 800

INDUSTRIAL BRACKETS SUPPLIED WITH ADJUSTABLE EXTENSION PIECES AND/OR SUPER LOAD KITS.

Part No.	Dimensions WxHxL mm	Max. Load
S-680-1 SUPER LONG	min 600x400x960 / max 640x400x960	300 kg
S-685-1 SUPER LOAD	min 600x400x960 / max 640x400x960	550 kg
S-683-1 SUPER LONG	min 600x400x960 / max 640x400x960 mm with 3 verticals	300 kg

SUPER LOAD KIT available separately

Part No.	Dimensions
S-800*	P100xH280xL130 mm



Information correct at time of going to press. Not all products are available in all regions.



POLYAMIDE BRACKET RANGE



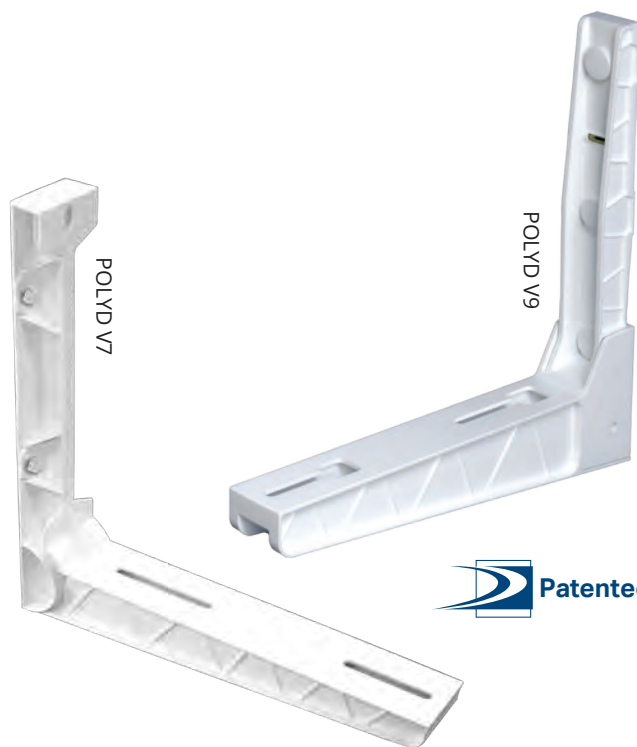

The choice of material comes from its particular characteristics: with sudden changes in temperature and humidity, polyamide regenerates instead of deteriorating, thus increasing its efficiency and keeping the load capacity of the bracket unchanged.

- Resistance, lightness and easyness in use;
- High mechanical performances;
- Excellent resistance to aging, corrosion, rust and atmospheric agents like UV-rays and saltiness;
- Can be used in areas with temperatures ranging from -20°C to +50°C.



POLYD V7



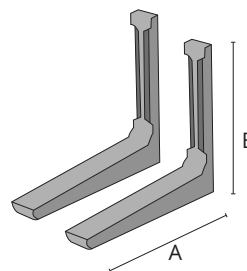

Fixed polyamide bracket

Part No.	AxB 	 Certified Load Capacity	Max. Load
9794-511-08	450 x 450	110 Kg 	330 Kg
9794-512-08	520 x 450	90 Kg 	270 Kg



POLYD V9

Foldable and pre-assembled polyamide bracket

Part No.	AxB 	 Certified Load Capacity	Max. Load
9794-515-08	450 x 450	110 Kg 	330 Kg
9794-516-08	520 x 450	90 Kg 	270 Kg

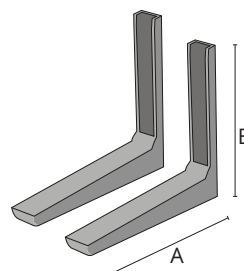

Information correct at time of going to press. Not all products are available in all regions.

07

SUPPORT & MOUNTING

ROOF BRACKET



ROOF BRACKET

ADJUSTABLE BRACKET FOR ROOF INSTALLATION

Adjustable inclination from 15° up to 30° according to the roof slope.

Part No.	Dimensions LxH mm
S-661	850x520 mm



Information correct at time of going to press. Not all products are available in all regions.

VIBRATION DAMPERS



The vibration damper is produced with different hardnesses (shore) identified by the color, in order to cover the widest range of applications. It resists atmospheric aging, UV rays and temperatures from -50°C to + 120°C. Distributed in kit of 4 pieces with screws for installation on bracket and/or on the ground.

Colour	For Condensers Up To	Part No.		Shore
		Blister	Box	
GREEN	100 KG	9898-037	9898-037B	35
YELLOW	200 KG	9898-038	9898-038B	45
RED	350 kg	9898-039	9898-039B	60
BLACK	450 KG	9898-040	9898-040B	70



DISPLAY STAND

The display can be assembled with different combinations of products. Available in metal for blister packs and cardboard for boxes.



DISPLAY STAND

Part No.

EXPO20



Information correct at time of going to press. Not all products are available in all regions.

VIBRATION DAMPERS



The vibration damper is made with different sections of the spring, corresponding to different hardnesses, in order to cover the widest range of applications. It is resistant to weathering, UV rays, and temperatures from -50°C to +120°C. Distributed in kit of 4 pieces in 2 colours to distinguish the different load capacity with screws for installation on bracket and/or on the ground.

Colour	For Condensers Up To	Part No.	
		Blister	Box
BLUE & GREEN	55 KG	9898-134	9898-134B
BLUE & YELLOW	80 KG	9898-135	9898-135B
YELLOW & RED	120 KG	9898-136	9898-136B



Display Stand

Part No.

EXPO20



The anti-vibration mount is made with different sections of spring, corresponding to different hardnesses, in order to cover the widest range of applications. Even more resistant thanks to the reinforced thermoplastic cover. Resistant to atmospheric ageing, UV rays and temperatures from -50°C to +120°C. Distributed in kits of 4 pieces in 2 colours to differentiate the different load capacities, with screws for mounting on brackets and/or on the ground.

Colour	For Condensers Up To	Part No.	
		Blister	Box
BLUE & GREEN	55 KG	9898-034	9898-034B
BLUE & YELLOW	80 KG	9898-035	9898-035B
YELLOW & RED	120 KG	9898-036	9898-036B



Display Stand

Part No.

EXPO20



Information correct at time of going to press. Not all products are available in all regions.

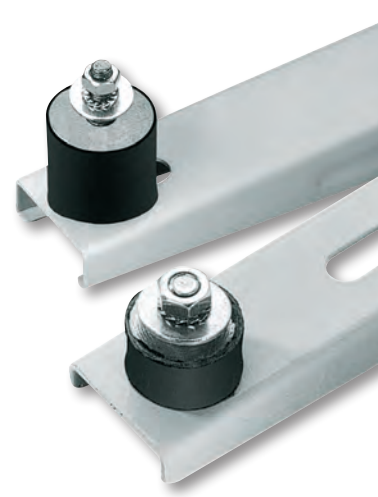

ANTI-VIBRATION DAMPERS

Made of vulcanised natural rubber with threaded metal inserts, they isolate and, in many cases, completely eliminate vibrations produced by machines. Supplied in packs of 4 vibration dampers, complete with nuts and washers.

	Part No.	Dimensions		
 9899-023 9899-023 9899-024 9899-024	9898-023	35x25	50 Kg	
	9898-024	40x20	50 Kg	
	9898-019	40x25	80 Kg	
	9898-028	30x20	50 Kg	
	9898-027	40x40	100 Kg	
	9898-025	48x20	80 Kg	
	9898-022	56x20	150 Kg	
	9898-018	56x20	250 Kg	
	9898-026	40x40	80 Kg	

AV Pads

AV Pads come in a range of sizes and offer isolation against vibration between the unit and the Big Foot Frame.

KEY FEATURES ↓

- ✓ Anti-vibration core.
- ✓ Outer layer corrugated anti-slip rubber.
- ✓ Available in 6 sizes.

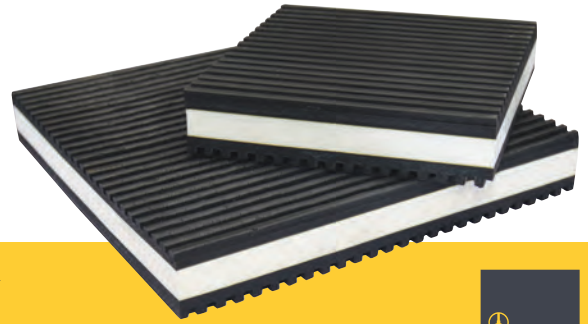

Description	Product Code	Length (mm)	Width (mm)	Height (mm)
51 mm	B6909	51	51	22.2
76 mm	B6910	76	76	22.2
101 mm	B6911	101	101	22.2
152 mm	B6912	152	152	22.2
305 mm	B6913	305	305	22.2
457 mm	B6914	457	457	22.2

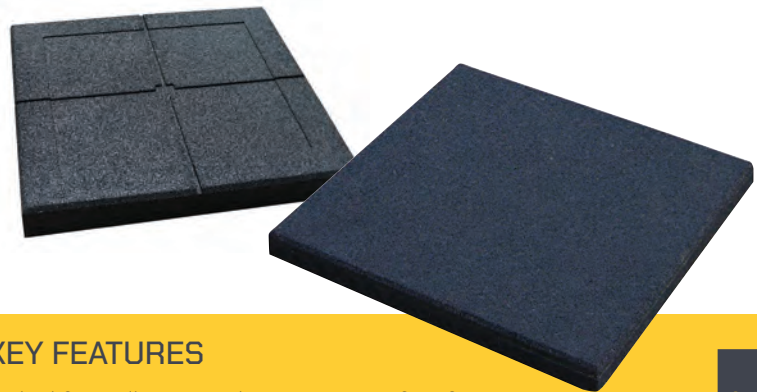

Vibromats

A range of durable rubber mats that can lay directly on the rooftop to protect it from potential damage from foot fall and ancillary equipment.

KEY FEATURES

- ✓ Ideal for walkways and to protect roof surfaces.
- ✓ Durable recycled rubber reduces vibration.
- ✓ 5 options available*.



Description	Product Code	Length (mm)	Width (mm)	Height (mm)
Small Strip*	B6491/1	600	150	30
Large Strip*	B6282/1	1000	500	30
Plain Tile 400	B9641	400	400	45
Plain Tile 500	B6416	500	500	45
400 with screws	167BB00662V	400	400	45
Plain Strip	B6024	1000	75	15

*NOTE: Small Strip and Large Strip include 2 no. steel plate core at either end.

Drip Trays

METAL

Condensate collection tray complete with hooks, equipped with a hole and Ø 20 mm drain for condensate drainage. Adaptable to any type of metal bracket and floor support.

Part No.	Dimensions WxD mm
S-097-71	850 x 390
S-095-71	940 x 390
S-096-71	940 x 420
S-093-71	1100 x 420
S-092-71	1400 x 420

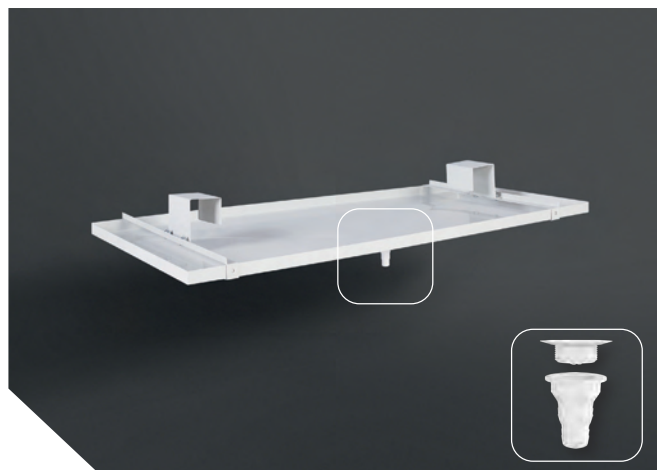

Drain Ø 20/25 mm
Code: 18580.01 available for sale



PLASTIC

Simple Plastic Condensate Collection Tray for Outdoor Units

Adaptable to all types of brackets on the market

Part No.	Dimensions WxDxH mm
9899-098-01	790 x 390 x 30
9899-099-01	945 x 425 x 40

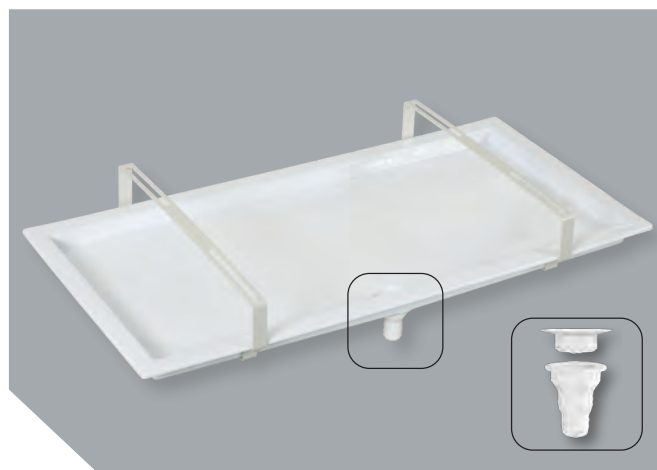

Drain Ø 20/25 mm
Code: 18580.01 available for sale



CONDENSATE WASTE WITH Ø 19/29/32 MM CONNECTION

Adaptable to the main external units on the market, with elastic press-fit closure. Supplied with 2 caps.

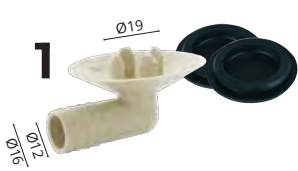

	Part No.	Size
1	9899-109	Ø 19
2	9899-108	Ø 32
3	9899-110	Ø 29

CONDENSATE WASTE



	Part No.	OD	ID	Qty
1	18580.01	Ø25 / Ø20	Ø 16	10
2	18581.01	Ø25 / Ø20	Ø 16	10

Vinyl Tubes	136
Rigid Pipe	137
Flexible Tubes	138
Drainage Fittings & Spares	139
Pipelounge	140-141
Connectors	142-143
Pipe Support Clips	144-150
Tape	151
Drain Cleaner & Unblocker	152

08

CONDENSATE MANAGEMENT & DRAINAGE



Vinyl Tubing

Flexible, durable and non toxic – we have the most extensive range on the market.

REINFORCED BRAIDED VINYL TUBE								
Description	Part No.	Diameter (mm)		Colour	Length (m)	Pressure (bar) @20°C	Burst Pressure (bar) @20°C	Temp. Range
		ID	OD					
1/4" (6mm)	AX5100	6	12	Clear	30	12	36	-5 °C - 65 °C
3/8" (10mm)	AX5101	10	14					
1/2" (12mm)	AX5102	16	22					
5/8" (15mm)	AX5103	15	20					
6/12 mm	AX5120	6	12	Clear	25	15	45	
10/16 mm	AX5121	10	16					
16/22 mm	AX5122	16	22					
19/26 mm	AX5123	19	26					
25/33 mm	AX5124	25	33	Black	30	5	15	
1/4" (6mm)	AX5110	6	12					
3/8" (10mm)	AX5111	10	14					
1/2" (12mm)	AX5112	16	22					
5/8" (15mm)	AX5113	15	20			6	18	



VINYL TUBE								
Description	Part No.	Diameter (mm)		Colour	Length (m)	Pressure (bar) @20°C	Burst Pressure (bar) @20°C	Temp. Range
		ID	OD					
1/4" (6mm)	AX5200	6	12	Clear	30	5	15	-5 °C - 65 °C
3/8" (10mm)	AX5201	10	14		30	4	12	
1/2" (12mm)	AX5202	16	22		30	3	11	
1/4" (6mm)	AX5203	6	12		10	4	12	
4/7 mm	AX5210	4	7	Blue	50	7	21	
6/9mm	AX5211/1	6	9		50	4	12	
6/9 mm	AX5211/F	6	9	Clear	50	4	12	
9/12 mm	AX5212	9	12			8	25	
10/14 mm	AX5213	10	14			8	25	
15/19 mm	AX5214	15	19			5	15	



CLEAR HOSE				
Part No.	Diameter (mm)		Colour	Length (m)
	ID	OD		
9899-049-00	9	6	Clear	25
9899-076-00	14	10		25



RIGID CONDENSATE DRAIN PIPE



Made of white (RAL 9010), shockproof, fireproof PVC stabilized against UV rays. Suitable for installation along as well as under wall. Hose and joints can easily be fitted by pre-mounted gaskets on the joints.

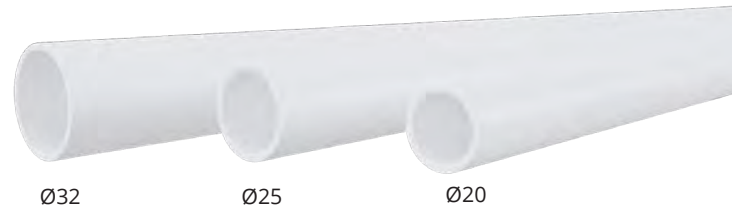

Part No.	Ø	
9899-040-08	0.9"	Ø 20 mm
9899-110-08	1"	Ø 25 mm
9899-120-08	1.2"	Ø 32 mm

PVC CONNECTORS FOR RIGID DRAIN PIPE

Sealing gasket to improve the grip on the rigid drain pipe.

Sealing gasket made of soft TPE with internal checkering

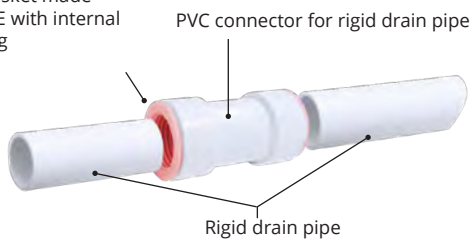

	Part No.	Ø	
FF SLEEVE	9899-041-08	0.9"	Ø 20 mm
	9899-111-08	1"	Ø 25 mm
	9899-121-08	1.2"	Ø 32 mm
90° BEND	9899-042-08	0.9"	Ø 20 mm
	9899-112-08	1"	Ø 25 mm
	9899-122-08	1.2"	Ø 32 mm
45° BEND	9899-043-08	0.9"	Ø 20 mm
	9899-113-08	1"	Ø 25 mm
	9899-123-08	1.2"	Ø 32 mm

PVC GLUE

Part No.

9899-047-08



	Part No.	Ø	
T-JOINT	9899-044-08	0.9"	Ø 20 mm
	9899-114-08	1"	Ø 25 mm
	9899-124-08	1.2"	Ø 32 mm
Ø25/20 MM PIPE REDUCER	9899-117-08	1"-0.8"	Ø 25-20 mm
	9899-127-08	1.2"-1"	Ø 32-25 mm
CONNECTING SLEEVE Connecting sleeve from flexible hose to rigid drain pipe.	9899-046-08	0.8"-0.8"	Ø 20-20 mm
	9899-116-08	0.8"-1"	Ø 20-25 mm
HOSE FIXING CLIP	9899-045-08	0.9"	Ø 20 mm
	9899-115-08	1"	Ø 25 mm
	9899-125-08	1.2"	Ø 32 mm



Information correct at time of going to press. Not all products are available in all regions.

COILED HOSE

Description	Part No.	Colour	Diameter (mm)		Length (m)	Pressure (bar)	Burst Pressure (bar)	Temp. Range		
			ID	OD						
Flexible coextruded hose	9899-053-01	White	16	18	50	n/a	n/a			
	9899-052-01		18	20						
Flexible Hose	9899-051-01	White	16	18	50	n/a	n/a			
	9899-050-01		18	20						
Flexible coextruded hose with M/F fitting	9899-054-01	Grey	6/18 and 18/20 mm		50	n/a	n/a			
	9899-059-01									14
Coiled hose	9899-055-01	White			30	n/a	n/a			
	9899-137-01									16
	9899-056-01									18
	9899-057-01									16
	9899-058-01									25
	9899-068-01									32

CONNECTORS FOR COILED HOSES

For multi-split installations, they convey the condensate outflow of two different units to one single pipeline. Suitable for coiled hoses only.

Part No.	Ø AxB		
9899-142-01	Ø 16/16 mm		A
9899-162-01	Ø 20/20 mm		B
9899-141-01	Ø 16/16 mm		A
9899-140-01	Ø 20/16 mm		B
9899-161-01	Ø 20/20 mm		



THREE-WAY CONNECTORS FOR FLEXIBLE HOSE

For multi-split installations, they connect the condensate outflow of two condensing units to one single pipeline. Suitable for flexible hoses only, supplied with gaskets.

Part No.	Ø	
1	9899-062-01	Ø 0.6"/0.7" Ø 16/18 mm
	9899-060-01	Ø 0.7"/0.8" Ø 18/20 mm
2	9899-066-01	Ø 0.6"/0.7" Ø 16/18 mm
	9899-064-01	Ø 0.7"/0.8" Ø 18/20 mm
3	9899-067-01	Ø 0.6"/0.7" Ø 16/18 mm
	9899-065-01	Ø 0.7"/0.8" Ø 18/20 mm



ADAPTER CONNECTIONS

Joints designed to connect rigid pipe to flexible drain hose. They are suitable for joining the outlet pipes of the evaporator to the pipe or hose of a different size. They allow easy connection to pipes Ø 14-16-18-20.

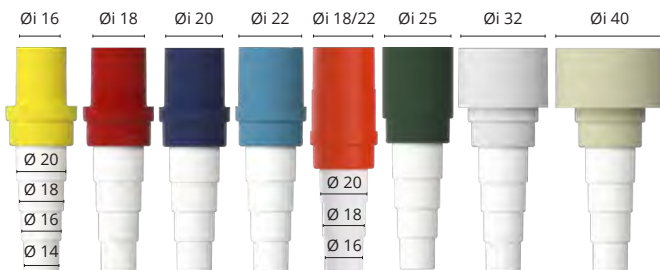

Part No.	ID		OD	
	Ø	mm	Ø	mm
9899-143-01	Ø 0.6"	Ø 16mm	Ø 0.76"	Ø 19.4mm
9899-144-01	Ø 0.7"	Ø 18mm	Ø 0.84"	Ø 21.4mm
9899-145-01	Ø 0.8"	Ø 20mm	Ø 0.92"	Ø 23.4mm
9899-149-01	Ø 0.9"	Ø 22mm	Ø 1"	Ø 25.4mm
9899-138-01	Ø 0.7"- 0.9"	Ø 18/22mm	Ø 0.84"/1"	Ø 21.4/25.4mm
9899-146-01	Ø 1"	Ø 25mm	Ø 1.12"	Ø 28.4mm
9899-147-01	Ø 1.2"	Ø 32mm	Ø 1.39"	Ø 35.4mm
9899-148-01	Ø 1.5"	Ø 40mm	Ø 1.71"	Ø 43.4mm

PIPE LOUNGE

**NEW &
INSTORE
TODAY!**

THE FASTEST WAY TO SUPPORT YOUR PIPEWORK!

The multi-pipe solution that simplifies your entire install.

THE PIPELOUNGE STORY



gb.pipelounge.com



Multi Pipe Support

Pipelounge pipe support systems keep pipe runs neatly organised, resulting in a professional, tidy finish on every install. Allowing expansion and contraction of multiple insulated pipes. This not only protects the pipework but also saves installers significant time and money by simplifying the installation process. **Faster. Neater. Smarter.**



PIPE LOUNGE



Channel













Rod



Surface

- UL 94 Classification – V0
- Versatile: Connect horizontally for wider spans or stack vertically in tight spaces.
- Economical & Robust: Ensures a high-quality installation for both new builds and retrofits.
- Fits M10 threaded rod.
- Pipelounge supports are rated for 50kg loads. For loads over 50kg a standard metal strut section must be used.

SPECIFICATIONS	
Material	PC ABS plastic
Max. Load	50kg (without metal support)
Sustainability	100% recyclable
Material	Fire retardant V-0 rated plastic

OPTIONS		
Part No.	Description	Box Qty
PLmini	Pipelounge Pipe Support 113 x 250mm Box	40 
PL150	Pipelounge Pipe Support 150 x 250mm Box	30 
PL200	Pipelounge Pipe Support 200 x 250mm Box	20 
PL300	Pipelounge Pipe Support 300 x 250mm Box	20 
PL400	Pipelounge Pipe Support 400 x 250mm Box	10 
PL500	Pipelounge Pipe Support 500 x 250mm Box	10 
PL600	Pipelounge Pipe Support 600 x 250mm Box	10 
PLjoiner	Pipelounge Joiner Clips Box	20 
PLpacker	Pipelounge Packers Box	20 
PLsticker	Pipelounge Refrigeration Stickers Box	100 

Scan here
for full range:



Please note, these products are sold in box quantities only.

Information correct at time of going to press. Not all products are available in all regions.



Tube & Connector Fittings

Adaptors / Straight Connectors

SIZING OPTIONS			
Size	Ideal Use	Part No.	Pack Qty
6 mm - 10 mm	Reduction of 6 mm (1/4") on 10 mm (3/8")	FP2020	5
6 mm, 10 mm, to 12 mm to 16 mm	1/4" to 3/8" to 5/8" to 1/2" for peristaltic pumps	FP2632	5

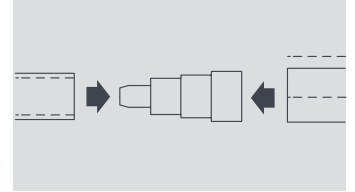

Non-return Valves

SIZING OPTIONS			
Size	Ideal Use	Part No.	Pack Qty
6 mm (1/4")	Prevents backflow of water	FP2628	5
10 mm (3/8")	Prevents backflow of water	FP2630	5

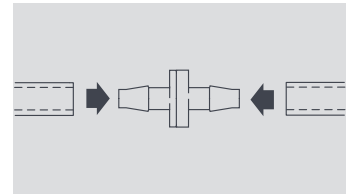

Hose to Hose

SIZING OPTIONS			
Size	Ideal Use	Part No.	Pack Qty
6 mm (1/4")	Equal "T" Connector	FP2024	5
6 mm (1/4")	Elbow Connector	FP2028	5
6 mm (1/4")	Straight Connector	FP2622	5
10 mm (3/8")	Equal "T" Connector	FP2030	5
10 mm (3/8")	Elbow Connector	FP2032	5
10 mm (3/8")	Straight Connector	FP2624	5
19/16 mm	Blue straight connector	209DV00012	50
16 mm	Blue Y Connector	209DV00017	10
16 mm	Blue Equal "T" Connector	209DV00018	10
16 mm	Blue Elbow Connector	209DV00019	10
16 mm	Blue Straight Connector	209DV00020	10

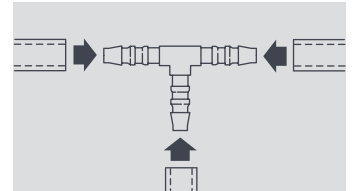

Hose to Overflow or Waste / Soil Pipe

SIZING OPTIONS			
Size	Ideal Use	Part No.	Pack Qty
6 mm (1/4") to 10 mm (3/8") - overflow pipe 21 mm	Hose to Overflow	FP2040	3
6 mm (1/4") to 10 mm (3/8") - self sealing adaptor	Hose to Waste / Soil Pipe (Drill hole to 11.5mm diameter)	FP2038	3

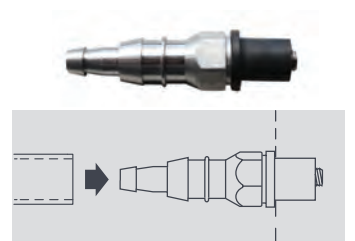
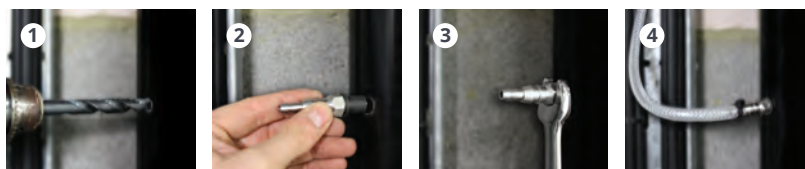
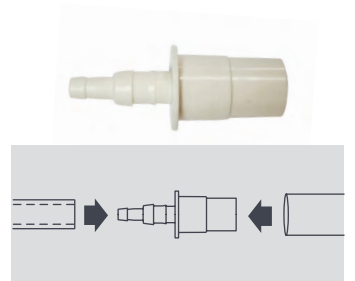

Note: All connectors should be fitted with the relevant cable ties



Rubber Connectors

Mini Pump

RUBBER ADAPTOR TO CONNECT A DUCTED UNIT TO A MINI PUMP

OPTIONS				
Ducted AC outlet OD	Reservoir Pump OD	Ideal Use	Part No.	Pack Qty
20 mm	16 mm	Mitsu Heavy	FP2001	3
25 mm	16 mm	Daikin, Mitsu Elec/Heavy, Panasonic, LG	FP2002	3
32 mm	16 mm	Daikin, Mitsu Elec/Heavy, Panasonic, LG	FP2003	3

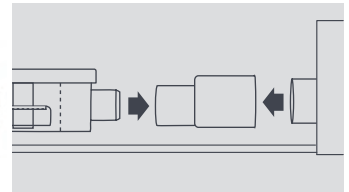

90° LONG ARM BEND TO CONNECT A WALL MOUNT TO MINI PUMP RESERVOIR

OPTIONS				
Drip tray outlet OD	Reservoir Pump OD	Ideal Use	Part No.	Pack Qty
12 mm	16 mm	LG wall mount and floor mount	FP2006	3
16 mm	16 mm	Wall mount and floor mount	FP2056	3

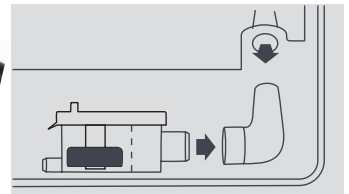

OFFSET CONNECTOR

OPTIONS				
Drip tray outlet OD	Reservoir Pump OD	Ideal Use	Part No.	Pack Qty
16 mm	16 mm	Can be used universally	FP1024	5

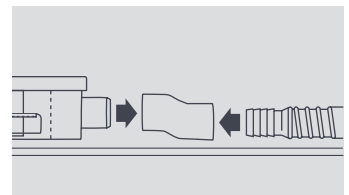

Tank Pump

RUBBER ADAPTOR TO CONNECT A CASSETTE UNIT CONDENSATE DRAIN PIPE TO A TANK PUMP

OPTIONS				
Cassette outlet OD	Overflow pipe OD	Ideal Use	Part No.	Pack Qty
16 mm	21 mm	Unités LG	FP2011	3
26 mm	21 mm	Daikin, Panasonic	FP2012	3
32 mm	21 mm	Daikin, Mitsu Elec/Heavy, Panasonic, LG	FP2013	3

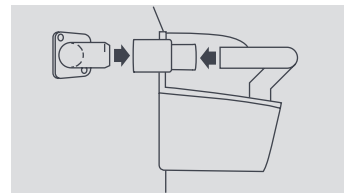

Pipe to Pipe

RUBBER ADAPTOR TO CONNECT 21MM OVERFLOW PIPE TO WASTE PIPE

OPTIONS				
Overflow pipe OD	Waste pipe OD	Ideal Use	Part No.	Pack Qty
21 mm	25 mm	Reducing or enlarging pipe diameters	FP2016	3
21 mm	32 mm	Reducing or enlarging pipe diameters	FP2017	3
21 mm	40 mm	Reducing or enlarging pipe diameters	FP2018	3

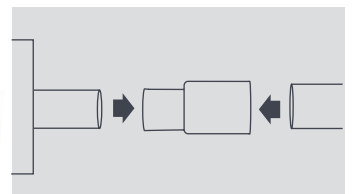

Note: All connectors should be fitted with the relevant cable ties

Information correct at time of going to press. Not all products are available in all regions.

Metal Hanger



A rod clip ideal for supporting air conditioning line set pairs.



Channel



Rod



Surface

Key Features

- Fits on both M8 and M10 studding
- Rapid 2 pipe installation
- Avoids the need for cable trays
- Zinc passivated to resist corrosion
- Ideal for when you need to meet fire regulations

SPECIFICATIONS

Materials of construction	Zinc passivated mild steel
Max. temp	1000 °C
Max. rec. distance per clip	1,2 m

SIZING OPTIONS

Description	Liquid*	Gas*	Part No.	Pack Qty
2	10 mm (3/8 ")	16 mm (5/8 ")	B6492/10	10
3	13 mm (1/2 ")	22 mm (7/8 ")	B6493/10	10
4	16 mm (5/8 ")	28 mm (1 1/8 ")	B6494/10	10

* Approximate pipe sizes (allowing for insulation)

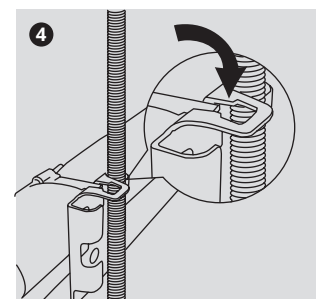
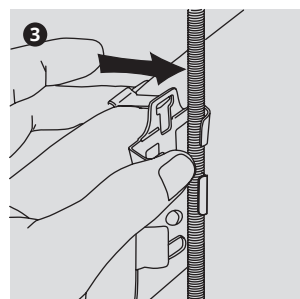
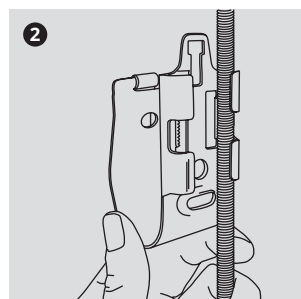
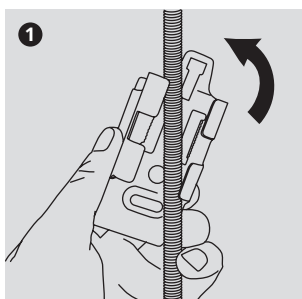

Stud Clip



Unique ratchet design ensures quick installation and adjustment.



Channel



Rod



Surface

Key Features

- Available for M8 and M10 studding
- Fast fixing direct to studding
- Simple to install, adjust and relocate
- Fits metric and imperial pipe sizes

SPECIFICATIONS		SIZING OPTIONS					M8	
Materials of construction	Nylon	Size	Lagging			Part No.	Pack Qty	
Max. temp	70 °C		6 mm	9 mm	13 mm	19 mm		
Max. rec. distance per clip	1,2 m							
		6 mm (1/4")					B6800/10 10	
		10 mm (3/8")					B6802/10 10	
		13 mm (1/2")					B6801/10 10	
		16 mm (5/8")					B6803/10 10	
		19 mm (3/4")	6 mm (1/4")				B6804/10 10	
		22 mm (7/8")	10 mm (3/8")				B6805/10 10	
		25 mm (1")	13 mm (1/2")	6 mm (1/4")			B6806/10 10	
		28 mm (1 1/8")	16 mm (5/8")	10 mm (3/8")			B6807/10 10	
		32 mm (1 1/4")	19 mm (3/4")	13 mm (1/2")			B6808/10 10	
			22 mm (7/8")	16 mm (5/8")				
		35 mm (1 3/8")		19 mm (3/4")	10 mm (3/8")		B6809/10 10	
					13 mm (1/2")			
		38 mm (1 1/2")	28 mm (1 1/8")	22 mm (7/8")	16 mm (5/8")		B6810/10 10	
		41 mm (1 5/8")	35 mm (1 3/8")	28 mm (1 1/8")	19 mm (3/4")	6 mm (1/4")	B6811/10 10	
					22 mm (7/8")	10 mm (3/8")		
		50 mm (2")				13 mm (1/2")	B6812/10 10	
		55 mm (2 1/8")	41 mm (1 5/8")	35 mm (1 3/8")	28 mm (1 1/8")	16 mm (5/8")	B6813/10 10	
				41 mm (1 5/8")	35 mm (1 3/8")	19 mm (3/4")		
						22 mm (7/8")		

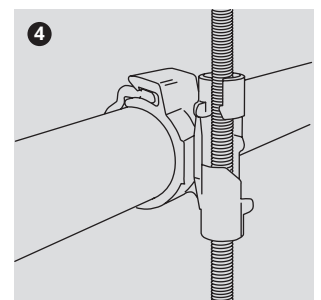
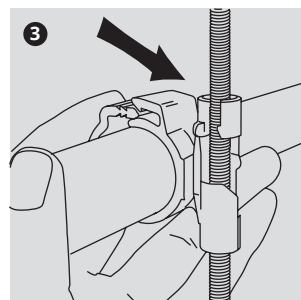
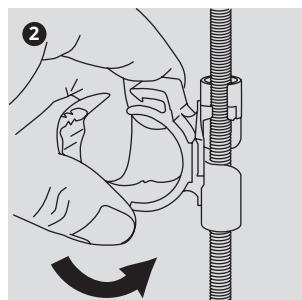
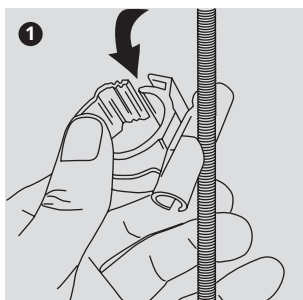

Information correct at time of going to press. Not all products are available in all regions.

Stud Clip M8 3 1/8" & 2 Pipe



A new range of stud clips that are ideal for refrigeration and air conditioning systems.



Key Features (Stud Clip (2 pipe) 3 1/8")

- The Stud Clip M8 31/8" is ideal for refrigeration pipework with a versatile ratchet from 54mm to 80mm pipe sizes
- Fast fixing direct to studding
- Fits metric and imperial pipe sizes

Key Features (Stud Clip 2 Pipe)

- Offers horizontal support for pipe sets on air conditioning systems
- Available for M8 and M10 studding
- Simple to install, adjust and relocate
- Secure extendable ratchet closure
- Clip encloses both line set and cables

SPECIFICATIONS	
Materials of construction	Nylon
Max. temp	70 °C
Max. rec. distance per clip	1,2 m

SIZING OPTIONS		
Size	Part No.	Pack Qty
Stud Clip 80 mm (3 1/8")	B7200/5	5
2 pipes 13 mm (1/2") – 22 mm (7/8") to 16 mm (5/8") – 28 mm (1 1/8")	B7205/5	5

Approximate pipe sizes (allowing for 13mm insulation)

STUD CLIP (2 PIPE) 3 1/8" INSTALLATION

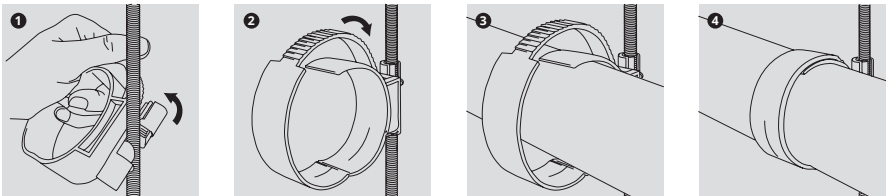

2 PIPE INSTALLATION

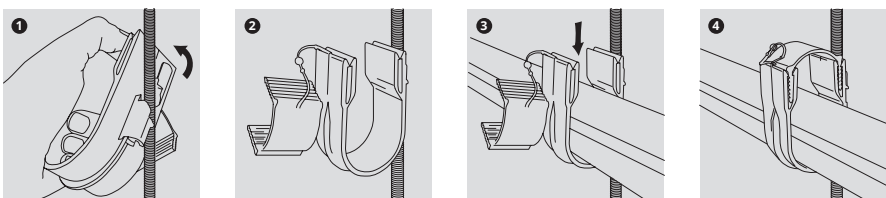

Information correct at time of going to press. Not all products are available in all regions.

Plastic Hanger



This dual stud size clamping system will fit securely to both M8 and M10 studding.



Channel



Rod



Surface

Key Features

- Easy installation
- Fits on both M8 and M10 studding
- Avoids the need for cable tray
- Adjustable clipping mechanism

SPECIFICATIONS

Materials of construction	Nylon
Max. temp	70 °C
Max. rec. distance per clip	1,2 m

SIZING OPTIONS

Description	Liquid*	Gas*	Rod Fitting Size	Part No.	Pack Qty
P2	10 mm (3/8")	16 mm (5/8")	8 ou 10 mm	B6543/5	5
P3	13 mm (1/2")	22 mm (7/8")	8 ou 10 mm	B6544/5	5
P4	16 mm (5/8")	28 mm (1 1/8")	8 ou 10 mm	B6545/5	5
P2	10 mm (3/8")	16 mm (5/8")	6 ou 8 mm	B6715/5	5
P3	13 mm (1/2")	22 mm (7/8")	6 ou 8 mm	B6716/5	5
P4	16 mm (5/8")	28 mm (1 1/8")	6 ou 8 mm	B6717/5	5

* Approximate pipe sizes (allowing for insulation)

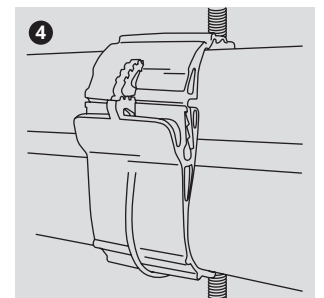
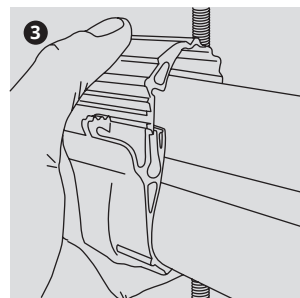
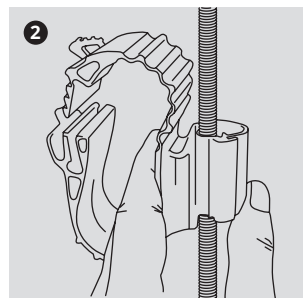
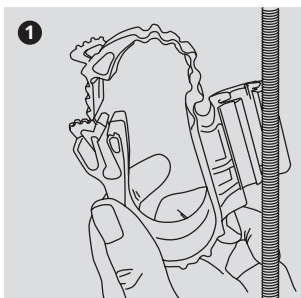



Information correct at time of going to press. Not all products are available in all regions.

Grab Clip



The Xtra Grab Clip rod clip is ideal for air conditioning line set pairs.

-  Channel
-  Rod
-  Surface

Key Features

- Grab Clip locates quickly to M8 and M10 studding
- Robust metal construction
- Snap shut lid secures pipe set
- Quick and easy pipe installation
- Wide metal construction for greater pipe support
- Can also be used for surface mount
- Ideal for when you need to meet fire regulations

SPECIFICATIONS

Materials of construction	Powder coated mild steel
Max. temp	1000 °C
Max. rec. distance per clip	1,2 m

SIZING OPTIONS

Description	Liquid*	Gas*	Part No.	Pack Qty
2	10 mm (3/8")	16 mm (5/8")	B2080/10	10
3	13 mm (1/2")	22 mm (7/8")	B2081/10	10
4	16 mm (5/8")	28 mm (1 1/8")	B2082/10	10

* Approximate pipe sizes (allowing for insulation)

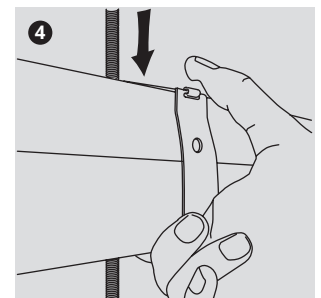
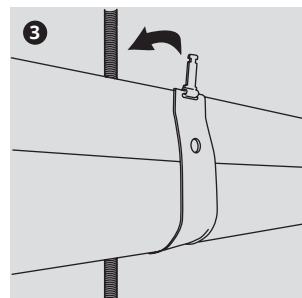
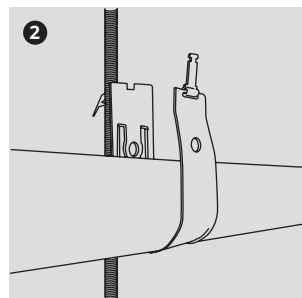
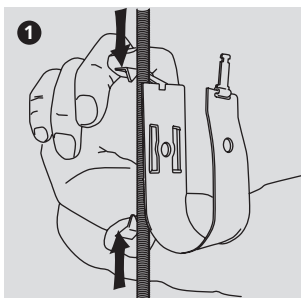

Information correct at time of going to press. Not all products are available in all regions.

3 Pipe Clip

The uniquely designed Xtra 3 Pipe Clip provides support for VRV / VRF systems pipework.



Channel



Rod



Surface

Key Features

- Available for a wide range of pipe group sizes
- Locates to M8 and M10 studding
- Wide metal arms for greater pipe support
- No need for cable tray
- Hinge security cover plate fastens with one screw
- Can also be used for surface mount pipe support

SPECIFICATIONS

Materials of construction	Powder coated mild steel
Max. temp	1000 °C
Max. rec. distance per clip	1,2 m

SIZING OPTIONS

Description	Pipe groups from	Pipe groups to	Part No.	Pack Qty
1	10 mm (3/8") 16 mm (5/8") 19 mm (3/4")	13 mm (1/2") 19 mm (3/4") 25 mm (1")	B6361/5	5
2	13 mm (1/2") 28 mm (1 1/8") 19 mm (3/4")	16 mm (5/8") 25 mm (1") 28 mm (1 1/8")	B6362/5	5
3	16 mm (5/8") 28 mm (1 1/8") 28 mm (1 1/8")	19 mm (3/4") 35 mm (1 3/8") 28 mm (1 1/8")	B6363/5	5
4	22 mm (7/8") 35 mm (1 3/8") 28 mm (1 1/8")	19 mm (3/4") 41 mm (1 5/8") 35 mm (1 3/8")	B6364/5	5

Approximate pipe sizes (allowing for 13mm insulation)

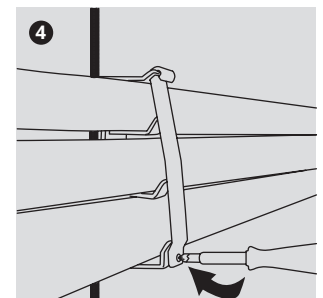
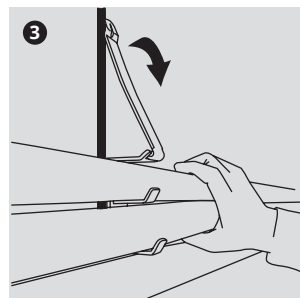
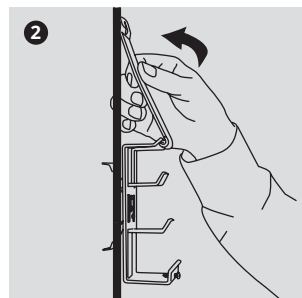
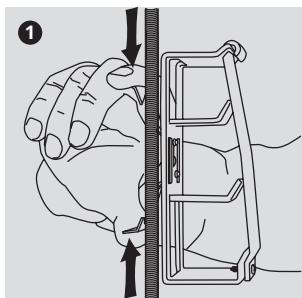

Information correct at time of going to press. Not all products are available in all regions.

Grip Lock

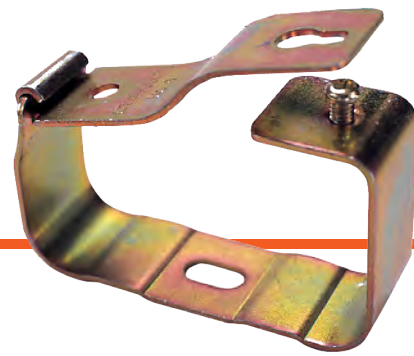

Best selling versatile clip mounts to any surface.
Ideal for air conditioning line sets.



Channel



Rod



Surface

Key Features

- Fits directly to a wall or solid ceiling
- Hinged for rapid pipe installation
- Space for electrical cables and condensate hose
- Zinc and colour passivated to resist corrosion
- Wide metal components for good pipe support

SPECIFICATIONS

Materials of construction	Zinc passivated mild steel
Max. rec. distance per clip	1,2 m
Max. temp	1000 °C

SIZING OPTIONS

Size	Liquid*	Gas*	Width (mm)	Height (mm)	Part No.	
Size 1	6 mm (1/4")	13 mm (1/2")	54	30	B6186/10	10
Size 2	10 mm (3/8")	16 mm (5/8")	60	32	B6187/10	10
Size 3	13 mm (1/2")	22 mm (7/8")	67	37	B6188/10	10
Size 4	16 mm (5/8")	28 mm (1 1/8")	80	46	B6189/10	10

* Approximate pipe sizes (allowing for 13mm insulation)

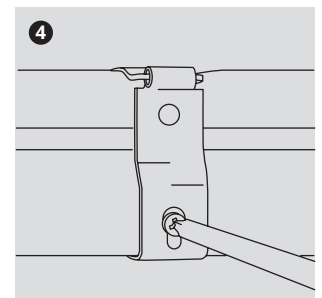
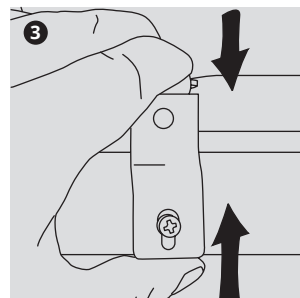
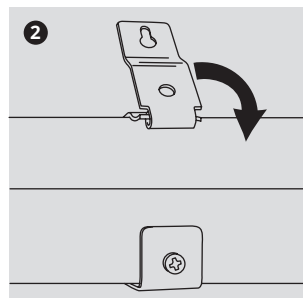
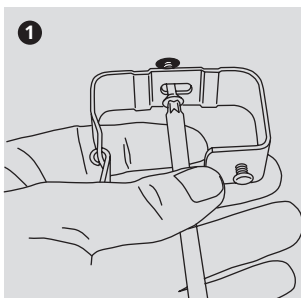

Information correct at time of going to press. Not all products are available in all regions.

Strut Clip

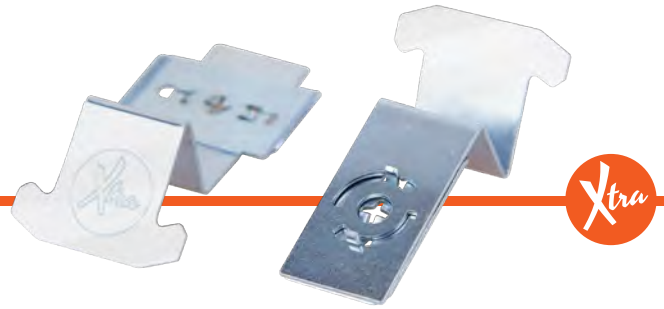

Xtra Strut Clips provide quick, secure mounting for wire cable tray installations.

- Quick and easy to install
- Secure mounting
- To be used in weather protected environment
- Load capacity: 40kg per Strut Clip
- Material: Spring Steel
- Finish: Galvanised Zinc Plated 50 Microns

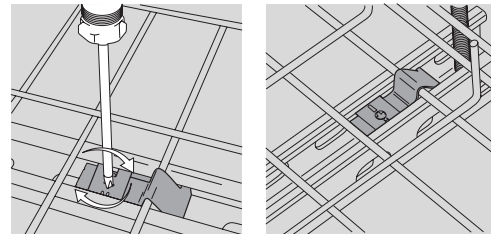

SIMPLY INSERT STRUT CLIP INTO CABLE TRAY CHANNEL, ENSURE BARBED END IS FACING DOWN. TURN WITH A SCREWDRIVER TO LOCK INTO PLACE.



SPECIFICATIONS



Description	Part No.
Strut Clip (Bag of 20)	B7000

CONDENSATION PREVENTION TAPE

Supplied in two versions (rubber or polyethylene). Class1 fire rating. Operating emperature: -15°C /+80°C.

Self-adhesive, condensation prevention aluminum tape with strong glue. Class 1 fire rating. Operating temperature: From -15°C /+80°C.

	Part No.	Dimensions	
	Rubber	9898-500	50 x 3 mm x 10 m
	Gray Polyethylene	9898-501	50 x 3 mm x 10 m
	White Polyethylene	9898-503	50 x 3 mm x 10 m

	Part No.	Dimensions	
	Aluminium	9898-400	50 x 3 mm x 10 m
	Reinforced Aluminium Tape	9898-401	50 x 3 mm x 10 m



VINYL TAPE

Non-adhesive elastic PVC rolls. Quick and easy to install, excellent acid resistance.

- External protective coating for insulated pipes
- Protection of underground pipes against oxidation and stray currents
- Protection of parts of manufactured items not to be treated in galvanic baths (e.g. chrome plating, zinc plating, etc.)
- Not recommended for use on pipes exposed to direct sunlight.

Part No.	Dimensions
9898-550-01	60m - h. 10 cm
9898-551-01	25m - h. 10 cm



Information correct at time of going to press. Not all products are available in all regions.

DrainKleen®

CONDENSATE DRAIN UNBLOCKER



Ready to use



Aerosol



Concentrate



Condensate pump safe

- Clears organic blockages
- Heavier than water – sinks to reach blockage site

Part No.	Product	Qty	Size
S010188GB	DrainKleen	4	5L

Hazardous transport.



DrainKleen® one shot

CONDENSATE DRAIN CLEANER & UNBLOCKER



Ready to use



Aerosol



Concentrate



Condensate pump safe

- Clears common blockages
- User friendly design for hard to reach areas

Part No.	Product	Qty	Size
S010106GB	DrainKleen one shot	12	250ml

Hazardous transport.



AdvancedGel DU

CONDENSER DRAIN UNBLOCKER



Ready to use



Aerosol



Concentrate



Condensate pump safe

- Heavy-duty formula clears organic and inorganic blockages
- Heavier than water, it will sink and find the blockage
- Safe to use with condensate pumps
- Makes 8 litres

Part No.	Product	Qty	Size
S010461R1	AdvancedGel DU	5	490 ml

Complies with EN1040, EN1275, EN1276 et EN14476.



Nonfood Compounds
Program Listed



Advanced

Information correct at time of going to press. Not all products are available in all regions.

11

CAGES & ACOUSTIC HOUSING

Design Box	170
Cages	171
Acoustic Housing	172



ASPEN
PUMPS
GROUP



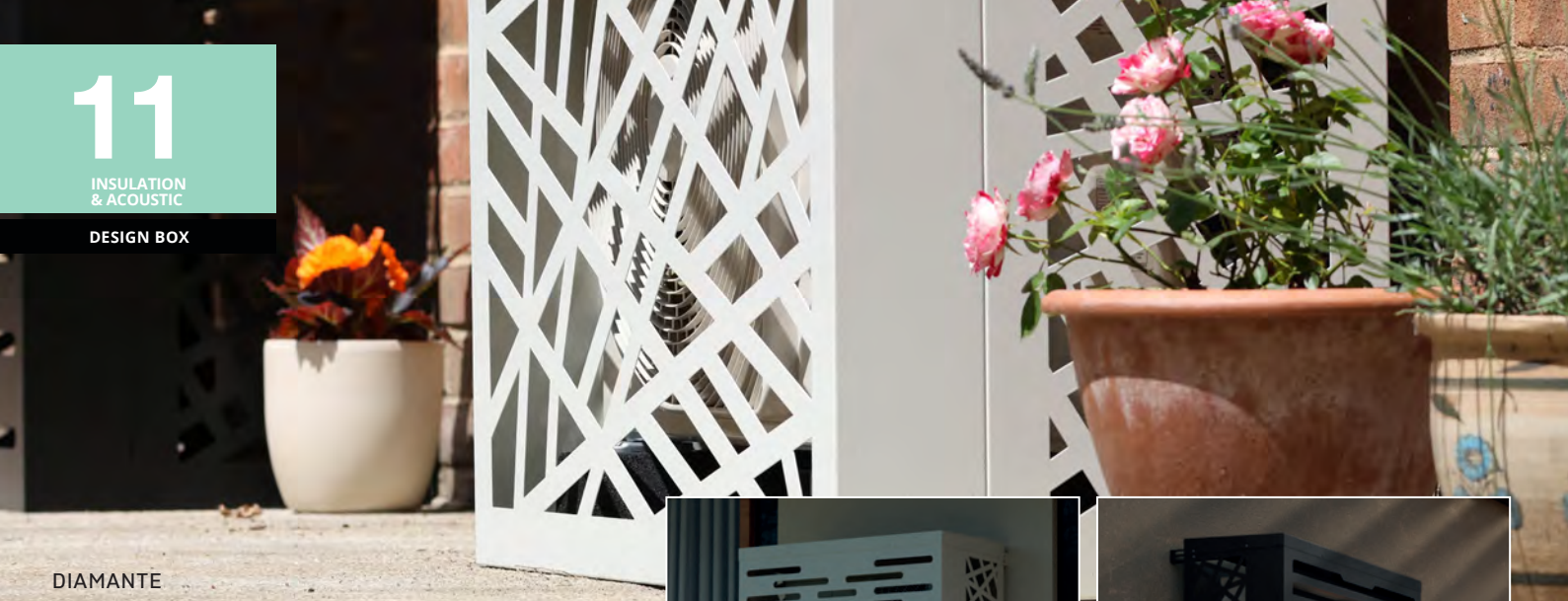

DIAMANTE



AMBRA



GIADA

DESIGN BOX



OUTDOOR CONDENSER UNIT COVER

Protected by a polyester powder coating, resistant to salt spray tests up to 500 hours of application time. Quick and easy assembly in minutes thanks to the quick-release fastening system. Adjustable extensions for convenient wall mounting. With our range of accessories, installation options include floor, wall or stand mounting.

AVAILABLE IN 3 MODELS AND 3 COLOURS!

DIAMANTE

Size	Part No.			W x H x D* - mm *D min - max (Extension kit)
	RAL 9002	RAL 7016	RAL 9005	
S	M38-910-71	M38-910-16	M38-910-95	900 x 680 x 450 - 650
M	M38-911-71	M38-911-16	M38-911-95	1050 x 950 x 650 - 850
L	M38-912-71	M38-912-16	M38-912-95	1150 x 1200 x 650 - 850
XL	M38-915-71	M38-915-16	M38-915-95	1400 x 1200 x 650 - 850
XXL	M38-913-71	M38-913-16	M38-913-95	1400 x 1600 x 650 - 850
3XL	M38-914-71	M38-914-16	M38-914-95	1400 x 2000 x 650 - 850

AMBRA (SOUND PROOFING SYSTEM AVAILABLE)

Size	Part No.			W x H x D* - mm *D min - max (Extension Kit)
	RAL 9002	RAL 7016	RAL 9005	
S	M18-910-71	M18-910-16	M18-910-95	900 x 680 x 450 - 650
M	M18-911-71	M18-911-16	M18-911-95	1050 x 950 x 650 - 850
L	M18-912-71	M18-912-16	M18-912-95	1150 x 1200 x 650 - 850
XL	M18-915-71	M18-915-16	M18-915-95	1400 x 1200 x 650 - 850
XXL	M18-913-71	M18-913-16	M18-913-95	1400 x 1600 x 650 - 850
3XL	M18-914-71	M18-914-16	M18-914-95	1400 x 2000 x 650 - 850

GIADA

Size	Part No.			W x H x D* - mm *D min - (Extension Kit)
	RAL 9002	RAL 7016	RAL 9005	
S	M48-910-71	M48-910-16	M48-910-95	900 x 680 x 450 - 650
M	M48-911-71	M48-911-16	M48-911-95	1050 x 950 x 650 - 850
L	M48-912-71	M48-912-16	M48-912-95	1150 x 1200 x 650 - 850
XL	M48-915-71	M48-915-16	M48-915-95	1400 x 1200 x 650 - 850
XXL	M48-913-71	M48-913-16	M48-913-95	1400 x 1600 x 650 - 850
3XL	M48-914-71	M48-914-16	M48-914-95	1400 x 2000 x 650 - 850



Information correct at time of going to press. Not all products are available in all regions.

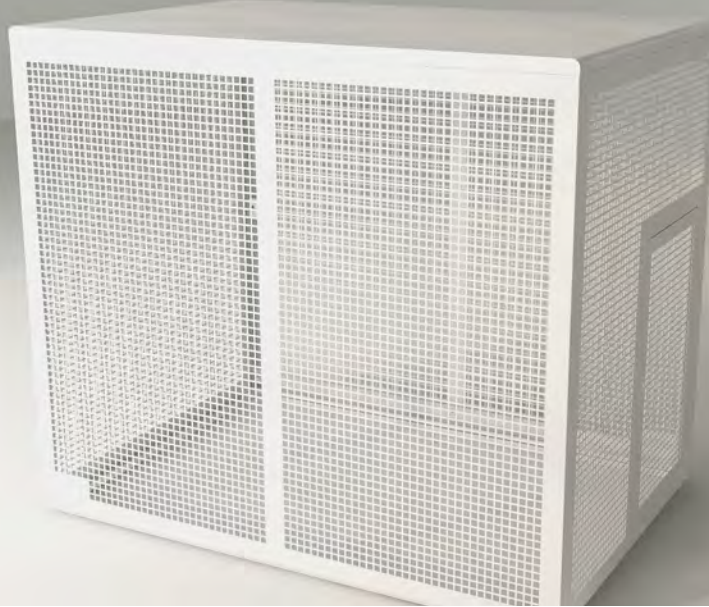

AGATA PROTECTIVE CAGE



71/White 16/ Anthracite 95/ Black

Protective cage for outdoor air conditioning units and heat pumps. Designed for quick installation and long service life. Thanks to a quick assembly system, no screws are required for installation. The wide range allows for the installation of a large number of units available on the market.

GENERAL FEATURES

- Easy installation thanks to the wall mounting bars supplied with spirit level.
- No screws for mounting or friction points, reducing the risk of rust formation.
- Epoxy powder coating for outdoor use, resistant to salt spray tests for up to 500 hours.
- Wide range of sizes available to cover all types of air conditioners and heat pumps.
- Inspection and maintenance door with square lock for access to the outdoor unit.
- 4 pre-drilled holes for pipes and cables.
- Available in three different colours: White RAL9002, Black RAL9005, Anthracite RAL7016.
- Hidden security system: allows the panels and cover to be screwed together if necessary.
- Optional rear panel for complete closure with the possibility of fixing to the ground.
- Optional condensate collection tray.

BUILDING MATERIALS

- Galvanised steel.

PRODUCTION PROCESS

- Punching.
- Laser cutting.
- Bending.
- Powder coating.

Back Panels	Part No.		
	RAL 9002	RAL 7016	RAL 9005
S	M58-PS910-71	M58-PS910-16	M58-PS910-95
M	M58-PS911-71	M58-PS911-16	M58-PS911-95
L	M58-PS912-71	M58-PS912-16	M58-PS912-95
XL	M58-PS913-71	M58-PS913-16	M58-PS913-95
XXL	M58-PS914-71	M58-PS914-16	M58-PS914-95
3XL	M58-PS915-71	M58-PS915-16	M58-PS915-95
4XL	M58-PS916-71	M58-PS916-16	M58-PS916-95

	Part No.			W x H x D - mm
	RAL 9002	RAL 7016	RAL 9005	
S	M58-910-71	M58-910-16	M58-910-95	1050 x 950 x 650
M	M58-911-71	M58-911-16	M58-911-95	1150 x 1200 x 650
L*	M58-912-71	M58-912-16	M58-912-95	1150 x 1600 x 650
XL*	M58-913-71	M58-913-16	M58-913-95	1150 x 2000 x 650
XXL	M58-914-71	M58-914-16	M58-914-95	1400 x 1200 x 950
3XL*	M58-915-71	M58-915-16	M58-915-95	1400 x 1600 x 950
4XL*	M58-916-71	M58-916-16	M58-916-95	1400 x 2000 x 950

* Modular cage: composed of 2 panels

2 Wall mounting bars with integrated spirit level

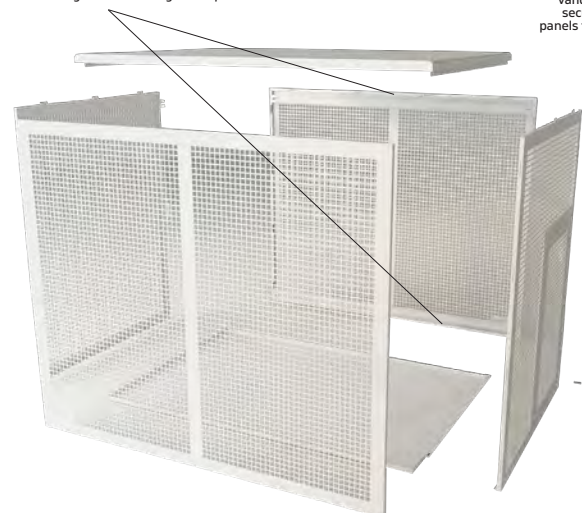

NEW INTEGRATED HIDDEN SECURITY SYSTEM: It prevents vandalism by securing bottom panels together.

Metal Trays	Part No.		
	RAL 9002	RAL 7016	RAL 9005
S	M38-111-71	M38-111-16	M38-111-95
M, L, XL	M38-112-71	M38-112-16	M38-112-95
XXL, 3XL, 4XL	M38-116-71	M38-116-16	M38-116-95



Information correct at time of going to press. Not all products are available in all regions.

Acoustic Housing Range

Acoustic enclosure up to 12 dB(A) sound reduction, measured according to DIN EN ISO 3744.

- Designed to reduce the noise emissions of refrigeration, air conditioners and heat pumps without compromising functionality
- Ingenious intake and exhaust air separation for optimum efficiency of the built-in outdoor unit
- Service and maintenance access possible
- Protection against weather and vandalism
- Can be adapted in colour to the environment
- Construction in Self-healing Magnelis: corrosion proof
- Sloped roof for rainwater drainage

ACOUSTIC HOUSING

2 models: rear air intake or lateral air intake

Easy installation HT100NP Rear air intake

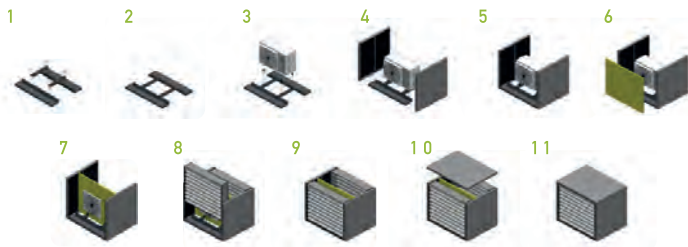

Detailed installation manual available on www.solflex.eu

Easy installation HT100NP Lateral air intake

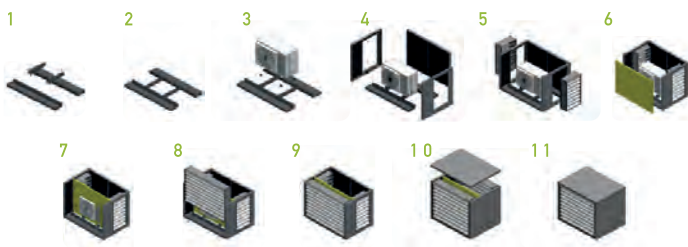

Sound insulation HT acoustic housing

Frequency (Hz)	63	125	250	500	1000	2000	4000	8000	16000
Sound insulation dB(A)	2	1	4	7	12	18	18	16	18

Solflex Type		Housing dimensions H x W x D (mm)	Weight (kg)	Max. dimensions for installation* H x W x D (mm)
Principle: rear intake, front exhaust				
HT100NP	Magnelis	1080 x 1210 x 910	140	1010 x 1100 x 450
HTX100NP		1080 x 1510 x 910	170	1010 x 1400 x 450
HTY100NP		1280 x 1210 x 910	160	1210 x 1100 x 450
HTXY100NP		1280 x 1510 x 910	180	1210 x 1400 x 450
HT200NP		1620 x 1210 x 910	200	1550 x 1100 x 450
HTX200NP		1620 x 1510 x 910	230	1550 x 1400 x 450
HTY200NP		1820 x 1210 x 910	220	1750 x 1100 x 450
HTXY200NP		1820 x 1510 x 910	250	1750 x 1400 x 450
HT100NPVI		1080 x 1400 x 1150	170	1010 x 1250 x 700
HTX100NPVI		1080 x 1700 x 1150	200	1010 x 1550 x 700
HTY100NPVI		1280 x 1400 x 1150	200	1210 x 1250 x 700
HTXY100NPVI		1280 x 1700 x 1150	230	1210 x 1550 x 700
HT200NPVI		1680 x 1400 x 1150	230	1610 x 1250 x 700
HTX200NPVI		1680 x 1700 x 1150	260	1610 x 1550 x 700
HTY200NPVI		1880 x 1400 x 1150	250	1810 x 1250 x 700
HTXY200NPVI		1880 x 1700 x 1150	280	1810 x 1550 x 700

Principle: lateral intake, front exhaust				
HT100NPS A	Magnelis	1080 x 1510 x 910	140	1010 x 1100 x 450
HTX100NPSA		1080 x 1810 x 910	170	1010 x 1400 x 450
HTY100NPSA		1280 x 1510 x 910	160	1210 x 1100 x 450
HTXY100NPSA		1280 x 1810 x 910	180	1210 x 1400 x 450
HT200NPSA		1620 x 1510 x 910	200	1550 x 1100 x 450
HTX200NPSA		1620 x 1810 x 910	30	1550 x 1400 x 450
HTY200NPSA		1820 x 1510 x 910	220	1750 x 1100 x 450
HTXY200NPSA		1820 x 1810 x 910	250	1750 x 1400 x 450
HT100NPS AVI		1080 x 1700 x 1150	170	1010 x 1250 x 700
HTX100NPS AVI		1080 x 2000 x 1150	200	1010 x 1550 x 700
HTY100NPS AVI		1280 x 1700 x 1150	200	1210 x 1250 x 700
HTXY100NPS AVI		1280 x 2000 x 1150	230	1210 x 1550 x 700
HT200NPS AVI		1680 x 1700 x 1150	230	1610 x 1250 x 700
HTX200NPS AVI		1680 x 2000 x 1150	260	1610 x 1550 x 700
HTY200NPS AVI		1880 x 1700 x 1150	250	1810 x 1250 x 700
HTXY200NPS AVI		1880 x 1700 x 1150	280	1810 x 1550 x 700

* The dimensions of the outdoor unit to be installed must be checked individually. For details, refer to the installation manual.

12

ELECTRICAL

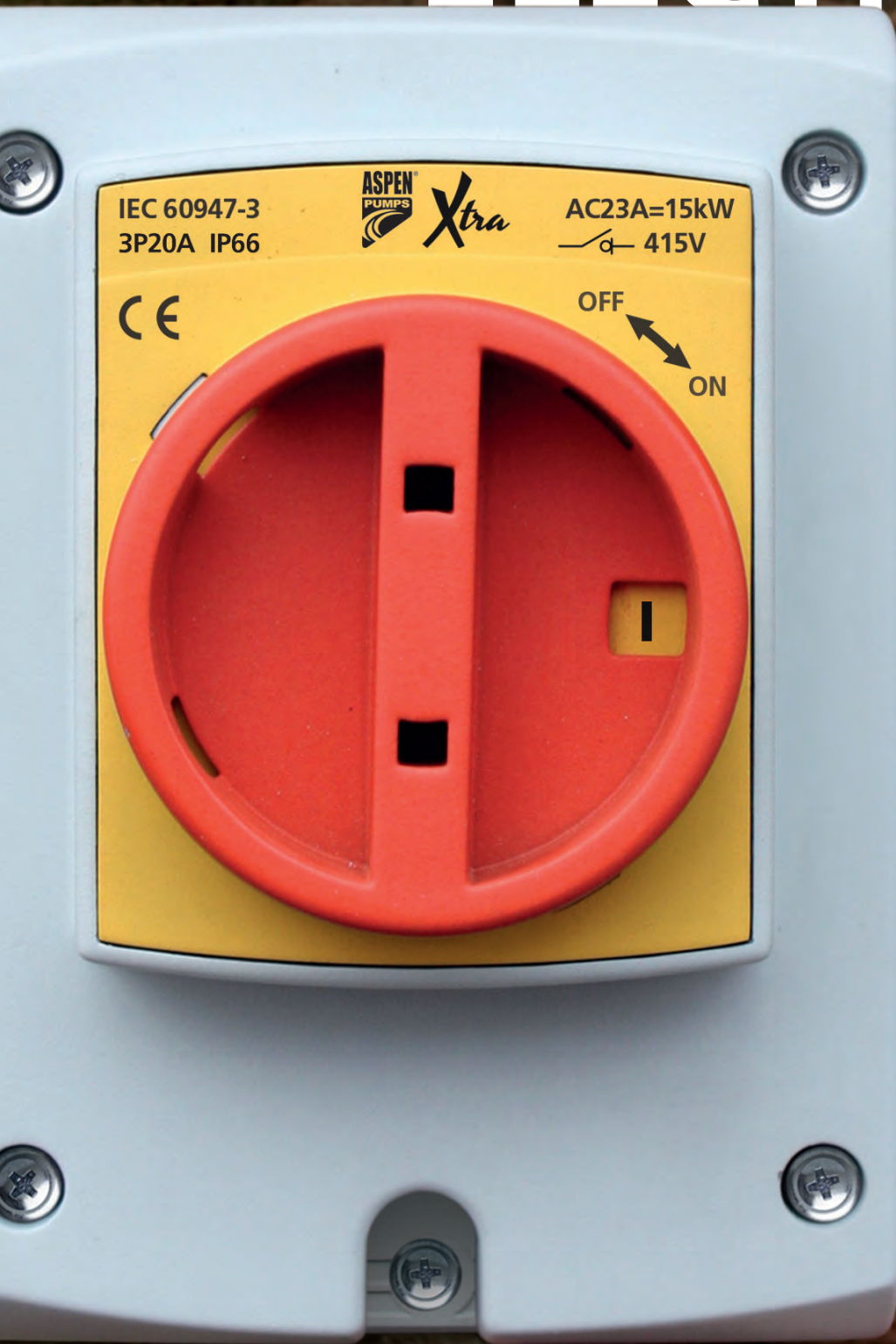

Isolators 174-175
Accessories 176



Isolator

Designed with the installer in mind. Large range of models and separate back plate for installation ease.

Key Features

- Separate back plate with spirit level for ease of installation
- 9 models available
- Surface mountable (with and without back plate)
- Removable switch for ease of wiring
- IP66 rated for interior and exterior use
- Lockable 'OFF' position (up to 2 padlocks) and 'ON' position (1 padlock), to prevent unauthorised access
- Fully compliant to IEC 60947-3
- 5 cable entry knock-outs
- Supplied with 2 cable glands

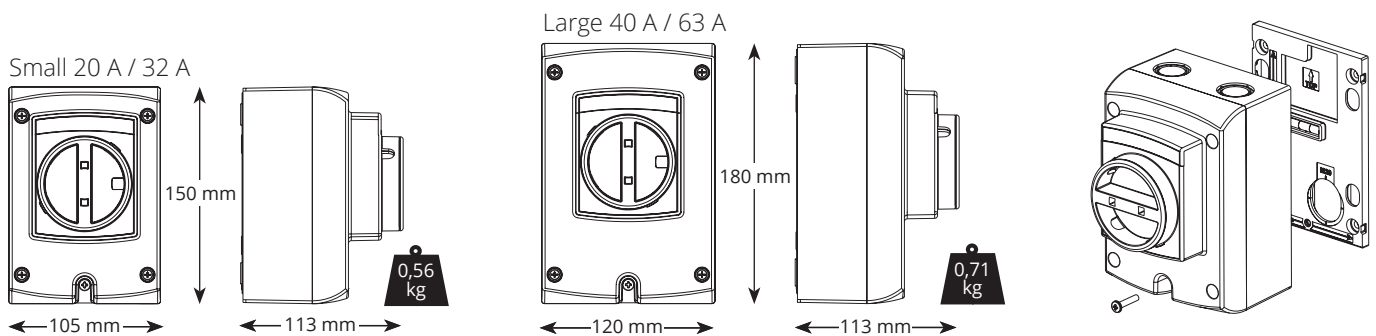

SPECIFICATIONS

Rated	415V AC
IP Protection	IP66

Raw material: Rigid, self-extinguishing, impact-resistant and UV-stabilised PVC.

SIZING OPTIONS

Description	Part No.
3-pole 20 A (small)	AX6101/2
3-pole 32 A (small)	AX6102/2
3-pole 40A (large)	AX6103/2
4-pole 20 A (small)	AX6001/2
4-pole 25 A (small)	AX6005/2
4-pole 32A (small)	AX6002/2
4-pole 40A (large)	AX6003/2
4-pole 63A (large)	AX6004/2

IN THE BOX

- Isolator
- Back plate with spirit level
- M4 x 20mm screw
- Install manual
- 2 x M20 glands & nuts (Small Isolator)
- 2 x M25 glands & nuts (Large Isolator)



Information correct at time of going to press. Not all products are available in all regions.



Isolator

Designed for versatility and ease, our isolator range features simple installation, multiple size options, and universal voltage compatibility—making it the smart choice for any HVAC setup.

Key Features

- Easy installation
- Compact and reliable
- Installation without penetrating the IP-rated enclosure
- 1 year guarantee

Large 40-63 Amp 4 Pole

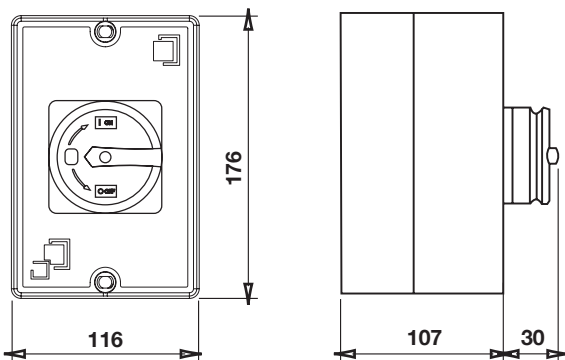

Small 20-32 Amp 4 Pole

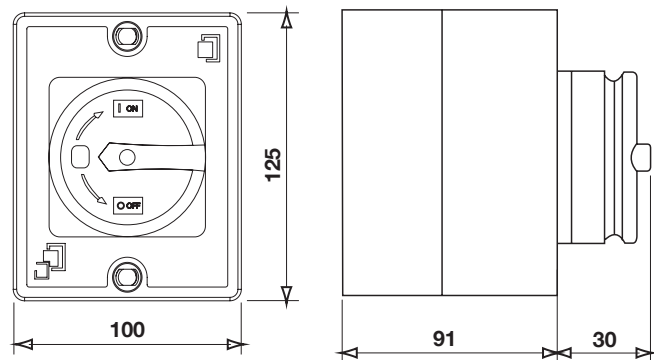

SIZING OPTIONS

Description	Part No.	Rating
Small 20 Amp 4 Pole	BK20A4P	AC21-20A/AC23A-5.5KW
Small 25 Amp 4 Pole	BK25A4P	AC21-25A/AC23A-7.5KW
Small 20-32 Amp 4 Pole	BK2032A4P	AC21-32A/AC23A-11KW
Large 40 Amp 4 Pole	BK40A4P	AC21-63A/AC23A-22KW
Large 40-63 Amp 4 Pole	BK4063A4P	AC21-40A/AC23A-15KW
Small 20 Amp 3 Pole	BK20A3P	AC21-20A/AC23A-5.5KW
Small 32 Amp 3 Pole	BK32A3P	AC21-32A/AC23A-11KW
Large 40 Amp 3 Pole	BK40A3P	AC21-40A/AC23A-15KW

SPECIFICATIONS

IP Protection IP65

IN THE BOX

Small Isolator includes 2x M20 Cable glands
Large Isolator includes 2x M20 Cable glands



Electrical Accessories

Mini Pumps

1 AMP FUSE AND HOLDER

Part No.

FP2620

(2 per pack)



Persaltic Pumps

ULTRA BLACK+ CABLE

Part No.

FP3386



ULTRA BLACK AIR CABLE

Part No.

FP3388



ULTRA BLACK+ SENSOR/RESERVOIR

Part No.

FP3387



ULTRA BLACK AIR TEMP. SENSOR

Part No.

FP3389



ES-6 | HEAVY DUTY 6" ELECTRICIANS SCISSORS



- Ultra tough 6" professional electricians scissors (160mm)
- Whole steel frame for high resistance & durability
- Industrial strength polypropylene handles
- With full TPR coating for superior grip & comfort
- High grade 4034 Japanese stainless steel 4.0mm thick polished blades with 40mm cutting edge
- Black 'DLC' (diamond-like-carbon) coating on blades for extra sharpness
- High hardness blades (58+2 HRC) with anti-slip serrated edge
- 2.5mm² & 1.5mm² wire strippers & wire crimping terminal
- Notch in the blades for cutting/stripping 50mm² cable
- Includes heavy duty nylon clip-on belt sheath
- Suitable for cutting aluminium, copper and soft cable
- Weight 153g | Dimensions Length: 160mm | Blade Length: 40mm



Information correct at time of going to press. Not all products are available in all regions.

13

MAINTENANCE

Evaporator	162-163
Condenser	164
Universal	165
Drain Maintenance	166
Refrigeration & Ice Machines	167
Specialist Chemicals	168-171
Heat Pump Cleaners	171
Accessories	172-174



ASPEN
PUMPS
GROUP



PurAire

EVAPORATOR CLEANER AND DEODORISER

Available in three formats, Advanced PurAire combats tough odours and grease while improving indoor air quality with an eco-friendly solution, comprehensive root cause treatment, and high-definition cleaning for lasting freshness.

- Active hydrophilic no-rinse technology
- Comprehensive root cause treatment
- High definition cleaning and freshness
- Rapidly emulsifies and removes grease, nicotine, grime and smelly dirt
- Easy to use with excellent performance
- Improved energy efficiency and indoor air quality
- NSF approved
- Available in three handy formats



Condensate pump safe



NSF approved

Part No.	Product	Qty	Size
S010197R1	PurAire Ready To Use	8	1L
S010126R1	PurAire Aerosol	12	600ml
S010160R1	PurAire Concentrate	4	5L

AdvancedGel EC

EVAPORATOR CLEANER



Ready to use



Aerosol



Concentrate

Condensate pump safe

- Powerful cleaning action will remove dirt from all waterproof surfaces effortlessly
- Improves energy efficiency of unit
- All in one indoor degreaser

Code	Product	Qty	Size
S010458R1	AdvancedGel EC	5	490 ml



RTU ECD®

EVAPORATOR CLEANER & DISINFECTANT



Ready to use



Aerosol



Concentrate



Condensate pump safe

- Verified to kill the SARS-CoV-2 virus (which leads to Covid-19) on contact†
- Kills 99.9% of bacteria in 60 seconds or less
- Convenient ready-to-use format





Part No.	Product	Qty	Size
S010196	RTU ECD	8	1L
S010192	RTU ECD	4	5L



Information correct at time of going to press. Not all products are available in all regions.

OdourGuard

ODOUR ELIMINATOR FOR A/C SYSTEMS

-  Ready to use
-  Aerosol
-  Concentrate
-  Condensate pump safe

- Continuous guard against odour release to ensure 360° protection for filters, AHUs and duct work
- Long lasting, subtle and naturally clean fragrance
- Compliments anti-viral protectors e.g. Advanced CondensCide and RTU ECD (ISO 18184:20189)





Code	Product	Qty	Size
S090070R1	OdourGuard	8	1L

Hazardous transport.



EasyFresh®

ODOUR NEUTRALISER FOR AC SYSTEMS

-  Ready to use
-  Aerosol
-  Concentrate
-  Condensate pump safe

- Specifically designed for air conditioning units
- Eliminates odours
- Produces a long-lasting fresh scent





Part No.	Product	Qty	Size
S090049GB	EasyFresh	12	400ml

Hazardous transport.



EasyCare®

CLEANER AND DISINFECTANT FOR EVAPORATORS

-  Ready to use
-  Aerosol
-  Concentrate
-  Condensate pump safe

- Verified to kill the SARS-CoV-2 virus (which leads to Covid-19) on contact†
- Kills 99.9% of bacteria in 60 seconds or less
- Improves indoor air quality
- Removes grease, nicotine and grime

Part No.	Product	Qty	Size
S010127	EasyCare	12	600ml

Hazardous transport.



SuperClean™

HEAVY-DUTY CONDENSER CLEANER



Ready to use



Aerosol



Concentrate



Condensate pump safe

- Powerful foaming action that brightens the coil and inhibits future oxidation
- Just as powerful as an acid-based cleaner, but safer to use
- Strongest coil cleaner in the market, unique formulation
- Makes 25 litres

Part No.	Product	Qty	Size
S010171GB	SuperClean	4	5L

Hazardous transport.



*Dilution: 3:1

EasyFoam®

FOAMING CONDENSER CLEANER



Ready to use



Aerosol



Concentrate



Condensate pump safe

- Powerful formulation makes it ideal for removing stubborn dirt from problem coils
- Perfect for deep, multi-row condensers
- Part of our Easy range of products

Part No.	Product	Qty	Size
S010132GB	EasyFoam	12	600ml

Hazardous transport.



RTU CC®

CONDENSER CLEANER



Ready to use



Aerosol



Concentrate



Condensate pump safe

- Convenient non foaming ready-to-use cleaner
- Improves system efficiency
- Great as part of a regular maintenance programme

Part No.	Product	Qty	Size
S010195GB	RTU CC	8	1L
S010191GB	RTU CC	4	5L







Advanced 

Information correct at time of going to press. Not all products are available in all regions.

VerteX[®]

NEUTRAL PH 7 CONDENSER & EVAPORATOR CLEANER

-  Ready to use
-  Aerosol
-  Concentrate
-  Condensate pump safe

- Non corrosive – neutral pH 7 adaptive cleaner
- Quickly removes rust, scale, grease and fat
- Ideal for microchannel and coils with protective coatings
- Neutralises all unpleasant malodour
- Makes 25-45 litres*





Part No.	Product	Qty	Size
S010389GB	VerteX	4	5L



*1:8 - Evaporators. 1:4 - Condensers.

EasyClean[™]

UNIVERSAL COIL CLEANER

-  Ready to use
-  Aerosol
-  Concentrate
-  Condensate pump safe

- Suitable for use on both air cooled evaporators and condensers
- Convenient, high powered aerosol with a safe formulation
- Attacks only the dirt, not the coil





Part No.	Product	Qty	Size
S010128GB	EasyClean	12	600ml

Hazardous transport.



EnviroCoil[®]

UNIVERSAL COIL CLEANER

-  Ready to use
-  Aerosol
-  Concentrate
-  Condensate pump safe

- Biodegradable, environmentally friendly and mild formulation
- Perfect for most maintenance, indoors or outdoors
- Contains no acids, phosphates, sodium/potassium hydroxide
- 5L: Makes 25-45 litres / 20L: Makes 100-180 litres*

Part No.	Product	Qty	Size
S010167	EnviroCoil	4	5L
S010312	EnviroCoil	1	20L



Information correct at time of going to press. Not all products are available in all regions.

DrainKleen®

CONDENSATE DRAIN UNBLOCKER



Ready to use



Aerosol



Concentrate



Condensate pump safe

- Clears organic blockages
- Heavier than water – sinks to reach blockage site

Part No.	Product	Qty	Size
S010188	DrainKleen	4	5L

Hazardous transport.



DrainKleen® one shot

CONDENSATE DRAIN CLEANER & UNBLOCKER



Ready to use



Aerosol



Concentrate



Condensate pump safe

- Clears common blockages
- User friendly design for hard to reach areas

Part No.	Product	Qty	Size
S010106	DrainKleen one shot	12	250ml

Hazardous transport.



AdvancedGel DU

CONDENSER DRAIN UNBLOCKER



Ready to use



Aerosol



Concentrate



Condensate pump safe

- Heavy-duty formula clears organic and inorganic blockages
- Heavier than water, it will sink and find the blockage
- Safe to use with condensate pumps
- Makes 8 litres

Code	Product	Qty	Size
S010461R1	AdvancedGel DU	5	490 ml

Complies with EN1040, EN1275, EN1276 et EN14476.







Nonfood Compounds Program Listed



Information correct at time of going to press. Not all products are available in all regions.

Jally® Strips

FOR CONDENSATE TRAYS

-  Ready to use
-  Aerosol
-  Concentrate
-  Condensate pump safe

- Slime dispersing action for refrigeration systems
- 12 months protection
- Safe to use in food preparation areas





Part No.	Product	Qty	Size
S010370GB	Jally Strips	1	50 strips
S010371GB	Jally Strips	1	6 strips

Hazardous transport.



Ice 'n' Clean®

ICE MACHINE CLEANER

-  Ready to use
-  Aerosol
-  Concentrate
-  Condensate pump safe





- Clears heavy limescale and slime deposits
- Nickel and aluminium safe – suitable for all ice machines
- Colour indicator ensures product is completely flushed
- New odourless formula

Part No.	Product	Qty	Size
S010169GB	Ice 'n' Clean	4	5L



AdvancedGel IMC

ICE MACHINE CLEANER

-  Ready to use
-  Aerosol
-  Concentrate
-  Condensate pump safe

- Clears heavy limescale and slime deposits
- Nickel and aluminum safe – suitable for all ice machines
- Colour indicator ensures product is completely flushed
- Cleans 1 unit

Code	Product	Qty	Size
S010460R1	AdvancedGel IMC	5	490 ml



Information correct at time of going to press. Not all products are available in all regions.

RTU[®] BU

BUBBLE-UP LEAK DETECTOR



Ready to use



Aerosol



Concentrate



Condensate pump safe

- Specifically designed for refrigerant leaks
- Produces long-lasting bubbles
- Clings to all surfaces

Part No.	Product	Qty	Size
S010173GB	RTU BU	8	1L

Hazardous transport.



EasyFind[®]

BUBBLE-UP LEAK DETECTOR



Ready to use



Aerosol



Concentrate



Condensate pump safe

- Specifically designed for refrigerant leaks
- Produces long-lasting bubbles
- Clings to all surfaces

Part No.	Product	Qty	Size
S010350GB	EasyFind	12	400ml

Hazardous transport.



EasyFinish[®]

FASCIA & CASE CLEANER



Ready to use



Aerosol



Concentrate



Condensate pump safe

- Suitable for most air conditioning units
- Safely removes finger marks etc. from plastic and metal casework
- Easily removes stubborn nicotine, grease & general grime
- Part of our Easy range of products





Part No.	Product	Qty	Size
S010131GB	EasyFinish	12	600ml

Hazardous transport.



EndoFlush®

INTERNAL COIL & SYSTEM CLEANER

-  Ready to use
-  Aerosol
-  Concentrate
-  Condensate pump safe





- For use after burnouts, before component changes or when retrofitting
- Will flush away sludge, carbon residues, acids, oils and water
- Low viscosity – flows easily

Part No.	Product	Qty	Size
S010190GB	EndoFlush	4	5L



EasyCoat™

ACRYLIC PROTECTIVE COATING FOR COILS

-  Ready to use
-  Aerosol
-  Concentrate
-  Condensate pump safe

- Effective corrosion protection for coils
- Indicator dye helps ensure complete coverage
- Rapid drying





Part No.	Product	Qty	Size
S010129GB	EasyCoat	12	600ml

Hazardous transport.



ScalePro™

LIMESCALE REMOVER FOR ADIABATIC CONDENSERS

-  Ready to use
-  Aerosol
-  Concentrate
-  Condensate pump safe

- Rapidly removes scale from condenser coils
- Restores system efficiency
- Safe on aluminium coils
- Perfect for adiabatic coolers

Part No.	Product	Qty	Size
S010147R1	ScalePro	4	5L







Advanced 

Information correct at time of going to press. Not all products are available in all regions.

CondensCide®

ALKALINE EVAPORATOR CLEANER & DISINFECTANT

-  Ready to use
-  Aerosol
-  Concentrate
-  Condensate pump safe

- Verified to kill the SARS-CoV-2 virus (which leads to Covid-19) on contact
- Kills 99.9% of bacteria in 60 seconds or less
- Improves energy efficiency and indoor air quality





Part No.	Product	Qty	Size
S010166	CondensCide	4	5L

Hazardous transport.



PyroCool®

FLAME RETARDANT GEL

-  Ready to use
-  Aerosol
-  Concentrate
-  Condensate pump safe

- Protects all surfaces and parts close to brazing, soldering and welding
- Reduces risk of fire by protecting surfaces and dissipating heat
- Suitable for copper, steel and aluminium pipework

Part No.	Product	Qty	Box Qty	Size
S050021GB	PyroCool	1	8	500ml
S050004GB	PyroCool	1	8	1L



SmellyJelly®

FRAGRANCING GEL

- Mini size: suitable for small fan coil units
- Size 1: suitable for large fan coil and cassette units





Part No.	Product	Qty	Size
S090017	SmellyJelly Citrus	20 cards	Mini
S090018	SmellyJelly Floral	20 cards	Mini
S090050	SmellyJelly Apple	20 cards	Mini
S090020	SmellyJelly Morning	20 cards	Mini
S090021	SmellyJelly Mountain	20 cards	Mini
S090057	SmellyJelly Orange	20 cards	Mini
S090054 MWE	SmellyJelly Mixed	20 cards	Mini



Information correct at time of going to press. Not all products are available in all regions.

StayClean® Detergent Tablets

CONDENSATE TRAY BACTERIAL CONTROL

-  Ready to use
-  Aerosol
-  Concentrate
-  Condensate pump safe





- Preventive anti-bacterial treatment for condensate tanks
- Controls odours
- Reduces sludge build-up
- Minimises risk of blockages
- Up to 8 weeks protection



Part No.	Qty	Size
S010105GB	20 tablets	1 pot

HeatClean RTU

HEAT PUMP CLEANER

-  Ready to use
-  Aerosol
-  Concentrate
-  Condensate pump safe

- Nature-based and 100% biodegradable.
- Made from organic salts derived from natural materials
- Suspends dirt particle in the presence of high concentration of cationic surfactants, cationic esters, and cationic polymers
- Dissolves and removes dirt to extensively improve thermal properties of Heat Pumps
- Easy to use with excellent performance



Code	Product	Qty	Size
S010163R1	HeatCleanRTU	8	1L
S010161R1	HeatClean	4	5L



Information correct at time of going to press. Not all products are available in all regions.

HydroSprayer®

CLEANER APPLICATOR

- Heavy duty low-pressure sprayer
- Suitable for use with all Advanced coil cleaner concentrates
- Full range of spares available

Part No.	Product	Qty	Size
S010107	HydroSprayer	1	8L
S010138	Replacement Seal Kit	1	-
S010139	Pump Assembly	1	-
S010140	Lance Assembly (includes nozzle)	1	-
S010141	Handle Assembly	1	-
S010142	Pressure Relief Valve	1	-
S010143	Lance, Nozzle & Hose Assembly	1	-



HydroSprayer® -Elite

BATTERY-POWERED ELECTRIC SPRAYER

- 15L tank capacity which is packaged as a back pack with supportive straps
- A 12V long-life rechargeable battery
- Powerful automatic pump that produces 60 psi at the squeeze of a trigger
- Use with Advanced concentrated and ready-mixed coil cleaner chemicals, both indoors and outdoors

Part No.	Product	Qty	Size
S010450	HydroSprayer-Elite	1	15L

The HydroSprayer-Elite is NOT suitable for use with ScalePro as the hydrochloric acid will dissolve the soft PVC parts, such as gaskets and the pump membrane.



Information correct at time of going to press. Not all products are available in all regions.

Squeezy™

PUMP PRIMING BOTTLE

The Squeezy pump priming bottle is the ideal contracting and service tool for checking all aspects of condensate removal.

- Allows you to check that the condensate removal pump is operating correctly
- The gooseneck spout makes it easy for the technician to dose in difficult places



Code	Product	Qty	Size
S010149	Squeezy	6	1L

EasyWipes™

PROFESSIONAL GRADE HAND WIPES

EasyWipes are professional hand wipes containing powerful yet safe cleaning agents. These convenient wipes dissolve and absorb dirt, grease, oil, paint and tar. Thanks to their sealed packaging, EasyWipes remain fresh. What's more, the packaging is so small that it can easily be stored in a toolbox or van compartment.

- New packaging with a snap-on lid, which helps keep wipes fresh for longer. Less waste!
- The package size has been increased from 50 to 100 wipes – a larger package means more product at an attractive price
- They clean surfaces quickly and effectively.
- Safe to use on hands
- Ideal for quick cleaning after work



Part No.*	Product	Quantity	Size
S010151R1	EasyWipes	1 box	12 packages

HookTite®

CLEANING COVER FOR CEILING AIR CONDITIONERS

- Ideal for routine maintenance
- Protects walls, carpets and surrounding equipment whilst cleaning
- Perfect for use with Advanced coil cleaners
- Access holes and a drain tube to ensure splash-free cleaning
- Time-saving – no dust sheets and no cleaning up afterwards



Part No.	Product	Qty	Size
S010122GB	HookTite	5	1000 x 1000mm

TieTite®

CLEANING COVER FOR WALL-MOUNTED INDOOR UNITS

- Ideal for use with high wall air conditioning units
- Protects walls, carpets and surrounding equipment whilst cleaning
- Provides protection to the user



Part No.	Product	Qty	Size
S010424GB	TieTite 1	Pack of 50 & Bucket	930 x 450mm
S010426GB	TieTite 2	Pack of 50 & Bucket	1100 x 450mm
S010119GB	TieTite Size 1	5	930 x 450mm
S010423GB	TieTite Size 1	Pack of 10	930 x 450mm
S010120GB	TieTite Size 2	5	1100 x 450mm
S010425GB	TieTite Size 2	Pack of 10	1100 x 450mm

Mimic®

UNIVERSAL A/C REMOTE CONTROL

- Compatible with most major air conditioner brands
- On screen ambient temperature
- Up to 4 unit codes can be stored: control 4 units at a time without reprogramming
- 1, 5 and 7 day programmable timer for more economical AC operation



Part No.	Product	Qty
S080019GB	Mimic	1



Information correct at time of going to press. Not all products are available in all regions.

14 TOOL STORAGE & BAGS

Veto EVO	176-178
Veto Pro Pac	179-185
Veto Norwalk	186

Scan here
for full range:



14

TOOL STORAGE
& BAGS

VETO EVO



Information correct at time of going to press. Not all products are available in all regions.

14

TOOL STORAGE
& BAGS

VETO EVO

VETO PRO PAC

TOOL BAGS THAT WORK

evo system

Evo – the ultimate wearable tool bag system designed for trade. Simply attach and deploy.

Hands free, fast access to tools, free body movement & weight distribution. Carry only what you need, where you need it.

The Evo system™ works using docks, clips and ultra strong magnets. Attach securely MOLLE tool pouches, suspenders, holsters and many attachments. One system. Countless possibilities.

WORK TACTICAL.



Scan for the
full EVO range



Information correct at time of going to press. Not all products are available in all regions.



Tech-Pac

BACKPACK TOOL BAG

Veto Pro Pac's Tech Pac is Veto's first backpack tool bag designed specifically for professional service and commissioning engineers carrying tools, laptops & service checkers. Ideal for the long walks on large sites and inner city calls outs.

- Adjustable padded shoulder straps
- Padded EVA thermoformed, ergonomic back padding
- Pocket for small tablet or laptop/multi purpose
- Internally stored aluminium hook to hang bag
- 46 interior & exterior pockets
- 5 year limited warranty

Rugged materials & construction

Waterproof base: 3mm Injection molded Polypropylene. **Weatherproof body fabric:** 950 and 1250 PVC Impregnated denier fabric. **Weatherproof tool pocket fabric:** 1800 PVC Impregnated denier fabric. **Quick release metal hasp:** Easy access to rear storage bay and creates positive shoulder strap load connection. **Handle:** Injection molded nylon plastic with over-molded rubber grip. **YKK® Zips:** Double stitched, heavy duty plastic coil zips with oversized zip tabs. **Press studs:** 6 zinc, marine grade. **D-Rings:** Powder coated steel. **Rivets:** 38 zinc, gun metal/marine grade rivets. **Stitching:** Industrial strength double nylon stitching.

Description	Part No.
Tech Pac	AX3501

Model specific specifications

Size mm – w/d/h	305x230x330 (400 with handle)
Weight (empty)	2kg
Storage/pockets	Vertical Tool Pockets: 46 interior and exterior tool pockets of various sizes. 2 Storage Bays – 4 Storage Platforms
Max. Payload	23kg
Internal volume	25L
D-Rings	4 large and 5 small
S/S Tape clip	✓
Plus	Quick release metal hasp

Information correct at time of going to press. Not all products are available in all regions.



Tech Pac Wheeler Blackout

WHEELED TOOLBAG

The Tech Pac Wheeler Blackout is a rolling version of the best-selling Tech Pac Blackout backpack tool bag with an all-black colour scheme. This wheeled backpack includes new premium padded backpack straps that are completely removable. This makes stowing the backpack straps easier and allows you to choose whether the bag can function as a backpack or not. The Tech Pac Wheeler Blackout also features the V-Swap™ system. Includes a tool panel and a meter panel. Other panels sold separately.

- Optional & stowable backpack shoulder harness
- Premium removable backpack straps with extra padding and enhanced materials for increased durability and load capacity
- Thermoformed cushioned EVA back pad

Description	Part No.
Tech Pac Wheeler Tool Bag	AX3709

Model specific specifications

Size mm – w/d/h	280x410x610
Weight (empty)	7.25kg
Storage/pockets	48 Interior and exterior tool pockets
Max. Payload	28kg
Internal volume	27L
Plus	8" Electrical Tape Strap



V-swap™ removable tool pocket panel system with alternate tool panels available & sold separately

Rugged materials & construction

Waterproof base: 3mm Injection molded Polypropylene. **Weatherproof body fabric:** 950 and 1250 PVC Impregnated denier fabric. **Weatherproof tool pocket fabric:** 1800 PVC Impregnated denier fabric. **Quick release metal hasp:** Easy access to rear storage bay and creates positive shoulder strap load connection. **Handle:** Injection molded nylon plastic with over-molded rubber grip. **YKK® Zips:** Double stitched, heavy duty plastic coil zips with oversized zip tabs. **Press studs:** 6 zinc, marine grade. **D-Rings:** Powder coated steel. **Rivets:** Gun metal/marine grade rivets. **Stitching:** Industrial strength double nylon stitching.

Information correct at time of going to press. Not all products are available in all regions.

14

TOOL STORAGE
& BAGS

VETO PRO PAC

VETO PRO PAC
TOOL BAGS THAT WORK

5 YEAR
ELECTRODOWNTIME
WARRANTY



TP-XXL

EXTRA LARGE TOOL POUCH

A closable extra-large sized tool pouch designed with integral side mounted padded meter pockets. Each zippered meter pocket will securely fit meters up to 260mm x 90mm x 50mm. The TP-XXL can be customized to hold a variety of tools, meters, fasteners, small tablet computer (rear pocket can accommodate tablet up to 9" x 11"), and various other gear.

- Includes rear tablet pocket & 2 Padded Meter Pockets
- "Hang-Up" Hook- Accessible While Open & Closed
- Over-Molded Rubber Grip
- Padded Shoulder Strap

Rugged materials & construction

Waterproof base: 3mm Injection molded Polypropylene.

Weatherproof body fabric: 950 and 1250 PVC Impregnated

denier fabric. **Weatherproof tool pocket fabric:** 1800 PVC

Impregnated denier fabric. **Quick release metal hasp:** Easy

access to rear storage bay and creates positive shoulder strap

load connection. **Handle:** Injection molded nylon plastic with

over-molded rubber grip. **YKK® Zips:** Double stitched, heavy

duty plastic coil zips with oversized zip tabs. **Press studs:** 6

zinc, marine grade. **D-Rings:** Powder coated steel. **Rivets:** Gun

metal/marine grade rivets. **Stitching:** Industrial strength double

nylon stitching.

Description	Part No.
TP-XXL Tool Pouch	AX3579
Model specific specifications	
Size mm – w/d/h	305x215x80 (560 with handle up)
Weight (empty)	14kg
Storage/pockets	46 total exterior and interior pockets; V-Swap™ Removable Tool Pocket Panel System; Includes rear tablet pocket & 2 Padded Meter Pockets
Max. Payload	14kg
Internal volume	12L
D-Rings	2- 2" and 5- 1"
S/S Tape clip	✓

Information correct at time of going to press. Not all products are available in all regions.



Tech-Pac Blackout

BACKPACK TOOL BAG

The Tech Pac Blackout is a blacked-out tool backpack for tool storage based on our Tech Pac but with Veto Pro Pac's V-Swap™ system that comes with front and back removable tool and meter pocket panels which are also exchangeable.

Note: This bag comes with the tool and meter panel. You do not have to select any panels for the bag to come with the tool and meter panels though you may purchase additional panels to offer a variety of configurations. Visit website for further details.

Rugged materials & construction

Waterproof base: 3mm Injection molded Polypropylene.

Weatherproof body fabric: 950 and 1250 PVC Impregnated

denier fabric. **Weatherproof tool pocket fabric:** 1800 PVC

Impregnated denier fabric. **Quick release metal hasp:** Easy

access to rear storage bay and creates positive shoulder strap

load connection. **Handle:** Injection molded nylon plastic with

over-molded rubber grip. **YKK® Zips:** Double stitched, heavy

duty plastic coil zips with oversized zip tabs. **Press studs:** 6

zinc, marine grade. **D-Rings:** Powder coated steel. **Rivets:** Gun

metal/marine grade rivets. **Stitching:** Industrial strength double

nylon stitching.

Description	Part No.
Tech-Pac Blackout Tool Bag	AX3561

Model specific specifications

Size mm – w/d/h	330x250x495 (560 with handle up)
Weight (empty)	5.5kg
Storage/pockets	Vertical Tool Pockets: 46 interior and exterior tool pockets of various sizes; Upper Pockets (Front Side) Designed For Extra Tool Capacity; Swap-Out Tool Panels- Front and Back Tool Panels are removable and exchangeable; Laptop Panel Available as an accessory (must be purchased separately) 2 Storage Bays- 4 Storage Platforms; Manifold Gauge and Hose Storage Pocket
Max. Payload	23kg
Internal volume	25L
D-Rings	4 large and 5 small
S/S Tape clip	✓
Plus	8" Electrical Tape Strap

Information correct at time of going to press. Not all products are available in all regions.



Hose Hauler Blackout

SERVICE TECH HOSE BAG

The Hose Hauler Blackout is a “blacked-out” version of the existing Hose Hauler with a few added features. It includes a “suitcase-like” expansion feature that increases internal capacity, allowing you to fit more hoses, store a refrigerant scale with your hoses and gear, or hold up to 100 feet of extension cord. Inside, a removable security strap keeps hoses or extension cords fastened and prevents them from unraveling.

The bag also features three removable zippered pouches—two corner pouches and one centre pouch—for storing tools and equipment. The flap includes a dual-zippered 2-in-1 pocket that opens from the top or bottom. On the outside, there is an added hanging hook for mounting the bag and a shoulder strap for easy transport. This is the ultimate bag for hoses, extension cords, and recovery or evacuation kits.

- Water/Oil Resistant Tarpaulin Interior for easy clean up
- “Hang-up” hook - accessible while open and closed
- Expansion feature to increase internal capacity
- Removable Internal Strap to secure hoses and cords and prevent unraveling
- Shoulder strap

Model specific specifications

Size mm – w/d/h	430x130x430
Weight (empty)	1.8kg
Storage/pockets	Up to 6 pockets
Max. Payload	7kg
Internal volume	11.2L
D-Rings	2 exterior
Molle Straps	2 exterior

Rugged materials & construction

Water/Oil Resistant Tarpaulin Interior for easy clean up; Rugged bottom to prevent tears and scratches; YKK® Zippers

Description

Tech Pac Hose Hauler Blackout

Part No.

AX3707



TECH PAC MCP INFRARED

BACKPACK TOOL BAG

The TECH PAC MCP INFRARED is a compact tool backpack in the new black and red color scheme. Identical in construction and storage capacity to the TECH PAC MC BLACKOUT – with the addition of side pockets for separate meter or tool storage. The bag also features external daisy chains for attaching pouches and accessories, as well as Velcro ideal for personalizing with morale patches. The TECH PAC MCP INFRARED also features our proprietary V-SWAP™ interchangeable panel system..

The TECH PAC MCP INFRARED bag comes with the tool panel and the meter panel. you can purchase more of these items, as well as additional add-on storage items.

- Infrared colour scheme
- 51 interior and exterior pockets 2 external side meter pockets
- Interior magnetic screw catcher
- External daisy chain for attaching pouches and accessories
- Quick release metal hasp supports load & allows easy access to rear storage bay
- Thermoformed cushioned EVA back pad and High Impact Polypropylene plastic base

Model specific specifications

Size mm – w/d/h	420x420x250
Weight (empty)	4.7kg
Storage/pockets	51 Interior 2 Exterior
Max. Payload	18kg
Internal volume	20.6L
D-Rings	4 Exterior
Molle Straps	2 Exterior

Rugged materials & construction

Water/Oil Resistant Tarpaulin Interior for easy clean up; Rugged bottom to prevent tears and scratches; YKK® Zippers

Description	Part No.
Tech Pac MCP Infrared	AX3703

Information correct at time of going to press. Not all products are available in all regions.



TECH MCTP INFRARED

COMPACT TALL TOOL BAG

The TECH-MCTP INFRARED is a compact service tool bag in the new black and red color scheme. Identical in construction and storage capacity to the TECH-MCT BLACKOUT – with the addition of side pockets for separate meter or tool storage. The bag also features external daisy chains, for attaching pouches and accessories as well as Velcro ideal for personalizing with morale patches. The TECH-MCTP INFRARED edition comes with the V-SWAP Tool Panel, and the V-SWAP Meter Panel. Additional panels are available and sold separately.

- Infrared colour scheme
- External Velcro loop for attaching patches
- 2 external side pockets for separate meter or tool storage
- Polypropylene plastic base for moisture and abrasion protection
- External daisy chain for attaching pouches and accessories
- Neoprene Pockets for Meters/Testers
- Extra wide padded shoulder strap

Model specific specifications

Size mm – w/d/h	410x380x210
Weight (empty)	3.9kg
Storage/pockets	55 Interior 2 Exterior
Max. Payload	18kg
Internal volume	15.3L
D-Rings	6 exterior
Molle Straps	2 exterior

Rugged materials & construction

Water/Oil Resistant Tarpaulin Interior for easy clean up; Rugged bottom to prevent tears and scratches; YKK® Zippers

Description	Part No.
Tech Pac MCTP Infrared	AX3702

Information correct at time of going to press. Not all products are available in all regions.



TP-XXL INFRARED

TOOL POUCH

The TP-XXL INFRARED is a closable mid-sized tool pouch in a new black and red colour scheme. It is identical to TP-XXL and includes integral side-mounted padded pockets for separate meter or tool storage. The bag also features an external daisy chain for attaching pouches and accessories

- Infrared colour scheme
- Waterproof Polypropylene plastic base
- Pass through "Hang Up" hook accessible when open or closed
- External daisy chain for attaching pouches and accessories
- Includes rear tablet pocket and two padded meter pockets
- Over moulded rubber grip
- Padded shoulder strap

Description	Part No.
TP-XXL Infrared	AX3705

Model specific specifications

Size mm – w/d/h	390x230x390
Weight (empty)	3.5kg
Storage/pockets	47 Interior & Exterior
Max. Payload	14kg
Internal volume	12L
D-Rings	2 Exterior
Molle Straps	1 Exterior

Rugged materials & construction

Water/Oil Resistant Tarpaulin Interior for easy clean up; Rugged bottom to prevent tears and scratches; YKK® Zippers

NORWALK 20L BACKPACK

Part No. VTO20002

TOP FEATURES:

- Recycled water resistant 600D waxed polyester
- Simple and versatile pocket layout with Hypalon touchpoints for easy access
- Separate padded laptop compartment with tablet sleeve; can store up to 17" laptops (depending on manufacturer)
- 2 dual-purpose magnetic side pockets with zip closure. Fitting up to 40 oz water bottles and small EDC items; compatible with the Stanley Quencher, Yeti Rambler, and more
- RFID-blocking front pockets
- Low profile key clip
- Breathable micro-mesh back padding
- Trolley handle pass-through



RFID-blocking front pocket with low profile key clip



Simple and versatile pocket layout



Padded laptop compartment with tablet sleeve



Innovative magnetic side pockets fit a wide range of water bottles

SPECIFICATIONS:

- DIM: 18"H x 12"W x 7"D
(46cm H x 30.5cm W x 18cm D)
- WT: 4 LBS (1.8 KG)
- VOL: 20L
- MAX PAYLOAD: 25 LBS (11.30 KG)



Information correct at time of going to press. Not all products are available in all regions.

15 LIGHTING & TORCHES



Site Lights	188-190
Inspection Lights	191-201
Head Torches	202-205
Flashlights	206-207
ATEX Lights	208-210



**ASPEN
PUMPS
GROUP**

14

LIGHTING
& TORCHES

SITE LIGHTS



MTB-5300 | MULTI BATTERY HYBRID WORK LIGHT

- 5300 lumen 50W 6500K COB LED
- Dual Power - rechargeable & mains powered
- Takes up to 20V 6.0Ah batteries from Milwaukee, DeWalt, Makita & Metabo - 4 adapters included
- Secure battery compartment cover (note: larger 6.0Ah batteries may need to be used without cover)
- Super tough heavy duty nylon construction
- Easy carry rubber grip handle
- Rotating stand with holes for attaching tripod/magnet
- 4 x dim settings: 650 / 1350 / 2700 / 5300 lumen
- Memory Switch - remember last mode used
- Safety automatic switch-over from mains to battery in the event of power failure
- 2A USB Powerbank - works with any battery Installed
- 4 x Battery level & charging indicators
- Comes with 5 metre heavy duty 24V-2.7A H05RN-F charger/power lead (includes UK, EU, US & AU plugs)
- Unilite 14.8V 5.2Ah battery available to purchase separately (NOTE: Only Unilite battery can be charged via the lamp)

BATTERY Not included, bare tool
WEIGHT 1250g
DIMENSIONS W 238 x H 257 x D 181mm

NOTE: runtimes based on
Unilite 5.2Ah battery



LUMEN 5300LM | RUNTIME approx 2.5-16H | BEAM 95M | IP RATING IP65/IK07

Information correct at time of going to press. Not all products are available in all regions.



aspenpumps.com | +44 (0)1323 848842 | sales@aspenpumps.com | UK 188

14

LIGHTING
& TORCHES

SITE LIGHTS



MTB-10000 | MULTI BATTERY 360 SITE LIGHT

- Ultra bright 10000 lumen 6500K SMD LEDs
- Multiple colour temperatures - CCT: 2700k / 3500k / 4500k / 5500k / 6500k
- Takes up to 20V 6.0Ah batteries from Milwaukee, DeWalt, Makita & Metabo - 4 adapters included
- Secure battery compartment cover (note: larger 5.5Ah-6.0Ah batteries may need to be used without cover)
- Super tough heavy duty nylon & polycarbonate construction
- Milky diffuser lens for even light dispersion
- Easy carry rubber grip handle
- Concealed fold-out ultra tough steel hanging hook in base
- 2 screw holes in base for attaching magnets
- IP65 Dust & water resistant
- Heavy duty IK08 Shock proof
- Smart Memory Switch - remember last mode used
- 5 x Battery level & charging indicators
- Unilite 14.8V 5.2Ah battery available to purchase separately

BATTERY Not included, bare tool
WEIGHT 3650g
DIMENSIONS W 278 x H 256 x D 333mm

NOTE: runtime is based on the Unilite 14.8V 5.2Ah battery. Other batteries will vary.



LUMEN 10000LM | **RUNTIME** approx 1-10H | **BEAM** 89M | **IP RATING** IP65/IK08

Information correct at time of going to press. Not all products are available in all regions.

14

LIGHTING
& TORCHES

SITE LIGHTS



SLR-5500 | RECHARGEABLE WORK LIGHT

- 5500 lumen 50W white SMD LEDs, 6500k
- High power 7.4v 7500mAh Li-ion battery
- Removable battery with powerful 2A USB power bank
- With battery level and charging indicators
- Tough aluminium & polycarbonate construction
- Glow-in-the-Dark strip around reflector for extra visibility
- Built-in aluminium heat sink
- Anti-slip rubber grip handle
- Adjustable head to change light angle
- Acrylic LED diffuser for even light dispersion
- Super strong magnetic base
- Mains 12V 2A multi-country charger/power lead included (inc UK, EU, US & AU adaptors)
- 4-5 hours charge time

BATTERY	7.4v 7500mAh Li-ion Battery Pack
WEIGHT	2200g
DIMENSIONS	215 x 192 x 285mm



LUMEN 5500LM | RUNTIME 3-6H | BEAM 54M | IP RATING IP54

Information correct at time of going to press. Not all products are available in all regions.



aspenspumps.com | +44 (0)1323 848842 | sales@aspenspumps.com | UK 190

14

LIGHTING
& TORCHES

INSPECTION

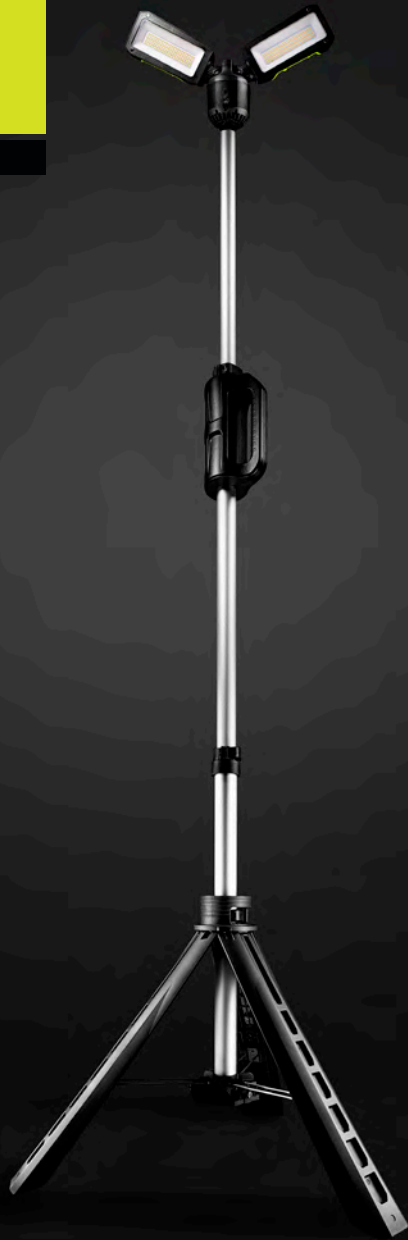

TL-6000 | SUPER TOUGH TRIPOD LIGHT

- Ultra bright 6000 lumen 6500K SMD LEDs
- Multiple colour temperatures - CCT: 2700k / 3500k / 4500k / 5500k / 6500k
- Dual Power - rechargeable and mains powered
- 2 Independent heads fold-out 90° and pivot 330° for light direction where its required
- Super tough heavy duty nylon, polycarbonate & aluminium construction
- Quick release set-up & fold down for rapid deployment/pack up
- Extends to 2.24m & folds down to 1.2m
- Smart Memory Switch - remembers last mode used
- IP65 dust & water resistant
- IK07 shock proof and 2m drop resistant
- High capacity 14.8V 5200mAh Li-ion battery
- 5 x Battery level and charging indicators
- Mains 20V 1.1A multi-country charger/power lead included (inc UK, EU, US & AU adaptors)
- Quick 4.5 hour charge time

BATTERY 14.8v 5200mAh Li-ion
WEIGHT 4400g
DIMENSIONS Folded: W 142 x H 1200 x D 142mm



LUMEN 6000LM | RUNTIME 2-16H | BEAM 64M | IP RATING IP65/IK07

Information correct at time of going to press. Not all products are available in all regions.

14

LIGHTING
& TORCHES

INSPECTION



PL-3 | INSPECTION PENLIGHT

- 275 lumen white SMD LEDs, 6500k
- Die cast aircraft grade aluminium construction
- Easy press rubberised micro-switch
- 3 Light mode settings
- Strong magnetic base
- Useful rear aluminium pocket clip
- IPX4 water resistant
- 1m drop resistant

BATTERY	3 x 1.5v AAA Alkaline Batteries (inc.)
WEIGHT	57g (without batteries)
DIMENSIONS	154 x 15 x 21.5mm

 **UNILITE**

LUMEN 275LM | RUNTIME 3-16H | BEAM 23M | IP RATING IPX4

Information correct at time of going to press. Not all products are available in all regions.



K-550 | COMPACT MINI WORK LIGHT

- 550 Lumen 5.7W white 6500K COB LED
- Press & Hold Turbo mode with additional red modes - 6 different lighting modes
- Ultra tough nylon & polycarbonate construction
- Super compact and lightweight size
- 160° Rotating stand with strong magnet
- Smart Memory - remembers last mode used
- Glow-in-the-Dark strip around led
- Comes with a carabiner and handy storage bag
- IPX6 water proof
- Powerful 3.7v 1200mAh li-polymer battery
- Useful battery level & charging indicators
- Fast 1A USB-C charging - 1.5 hour charge time
- 30cm USB-C charging cable included

BATTERY	3.7v 1200mAh Li-po
WEIGHT	74g
DIMENSIONS	54 x 28 x 60mm

*550 lumen is Turbo mode and operates by 'press & hold' switch with 1 hour total runtime. High mode is 375 lumen with 3 hour runtime.



LUMEN 550LM | RUNTIME 1*-28H | BEAM 29M | IP RATING IPX6

Information correct at time of going to press. Not all products are available in all regions.

14

LIGHTING
& TORCHES

INSPECTION



FLX-125 | TELESCOPIC MAGNETIC CAPTURE LAMP

- SMD White LED 6000K 125 lumens 1 W
- Extendable telescopic handle with flexible gooseneck to reach tight spaces
- Powerful magnet around the LED to serve as a pick-up tool
- Extends from 177 mm to 505 mm
- Ultra-lightweight compact pocket size
- Ultra-strong nylon and aluminium construction
- Smart memory switch - remembers the last mode used
- Useful pocket clip and ultra-powerful magnetic base
- Ultra-resistant IK09/IP65 construction
- IP65 dust and water resistant
- Protection against overcharging and excessive discharging
- 3-colour battery level indicator
- Green to green flashing charging light
- Fast USB-C 2A charging - Charging time of 2.5 hours
- High-quality 0.5 m USB-C cable included

BATTERY	3.7v 180mAh Li-ion
WEIGHT	88.8g
DIMENSIONS	177 x Ø21 x Ø17.5mm (closed)
	522 x Ø21 x Ø17.5mm (extended)

LUMEN 125LM | RUNTIME 2-6H | BEAM 13M | IP RATING IP65/IK09

Information correct at time of going to press. Not all products are available in all regions.



IL-425R | FOLDING INSPECTION LIGHT

- 425 lumen white COB LED, 6500k
- Secondary rear 150 lumen white SMD LED, 6500k
- Extra top torch - 80 lumen SMD LED, 6500k
- Ultra lightweight compact pocket size
- 180° vertical folding head
- Super tough aluminium & nylon construction
- Useful pocket clip
- Super strong magnetic base
- IK07 shock resistant - 2m drop resistant
- High quality 1100mAh li-ion battery
- Low battery 3x warning flash - reminds when charging is needed
- Quick 1A USB-C charging - 3 hour charge time
- 1m high quality USB-C cable included

BATTERY	3.7v 1100mAh Li-ion
WEIGHT	105g
DIMENSIONS	folded 147 x 33.5 x 21 mm extended 279 x 33.5 x 21 mm



LUMEN 425LM | RUNTIME 3-6.5H | BEAM 31M | IP RATING IP20/IK07

Information correct at time of going to press. Not all products are available in all regions.

14

LIGHTING
& TORCHES

INSPECTION



IL-925R | FOLDABLE INSPECTION LAMP

- 925-lumen Whitehe COB LED, 6500K
- 475-lumen secondary rear Whitehe COB LED, 6500K
- Additional top torch – 150-lumen SMD LED, 6500K
- Compact, portable design
- Ultra-resistant aluminium and nylon construction
- 180° vertical folding head
- Super powerful magnetic base
- IK07 shock resistant – Withstands drops from 2 m
- IP54 dust and water resistant
- High-quality 2600 mAh Li-ion battery
- Battery level and charging indicators
- Fast 1A USB-C charging – 4-hour charging time
- High-quality 1 m USB-C cable included

BATTERY 3.7v 2600mAh Li-ion
WEIGHT 193 g
DIMENSIONS folded 162 x 40 x 29 mm
extended 304 x 33 x 29 mm



LUMEN 925 LM | RUNTIME 2.5-9 H | BEAM 41 M | IP RATING IP54/IK07

Information correct at time of going to press. Not all products are available in all regions.

14

LIGHTING
& TORCHES

INSPECTION

 UNILITE



SLR-1450 | COMPACT WORK LIGHT

- 1450 lumen white COB LED, 6500k
- With 150 lumen 6500k white LED flashlight
- Plus 45 lumen Red and Red flash modes
- Powerful 'LG' 3.7v 5000mAh 21700 Li-ion battery
- Super tough copolymer and aluminium construction
- 180° rotating handle/stand with carabiner snap hook
- Strong magnets within the stand
- Glow-in-the-dark strip for extra visibility
- Battery level and charging indicators
- Faster 2A USB-C charging - 3 hour charge time
- 1m high quality USB-C cable included
- Battery can be removed so a convenient spare can be kept at hand
- 21700 battery has its own USB-C port so is easily charged out of the lamp

BATTERY 3.7v 5000mAh 21700 Li-ion
WEIGHT 288g
DIMENSIONS folded H 122.5 x W 50.5 x D 50.5mm
extended H 219 x W 50.5 x D 50mm

 UNILITE

LUMEN 1450LM | **RUNTIME** 3-90H | **BEAM** 53M | **IP RATING** IPX5

Information correct at time of going to press. Not all products are available in all regions.

14

LIGHTING
& TORCHES

INSPECTION



SLR-1750 | WORK LIGHT WITH POWERBANK

- 1750 lumen white COB LED, 6500k
- Red LED modes for emergency / signalling / night vision
- Built-in USB power bank with multiple intelligent outputs - 5V-3A/9V-2A/12V-1A
- Super tough copolymer and aluminium construction
- 180° rotating handle/stand with carabiner snap hook
- Strong magnets within the stand
- Glow-in-the-dark strip for extra visibility
- Super high power 'LG' 10,400mAh battery
- Battery level and charging indicators
- Faster 4 - 4.5 hour USB-C charging with multiple inputs - 5V-3A/9V-2A
- 1m high quality USB-C cable included

BATTERY	3.7v 10,400mAh Li-ion
WEIGHT	600g
DIMENSIONS	folded - 102 x 158 x 55mm extended - 102 x 268 x 48mm



LUMEN 1750LM | RUNTIME 4.5-195H | BEAM 50M | IP RATING IPX5

Information correct at time of going to press. Not all products are available in all regions.

14

LIGHTING
& TORCHES

INSPECTION

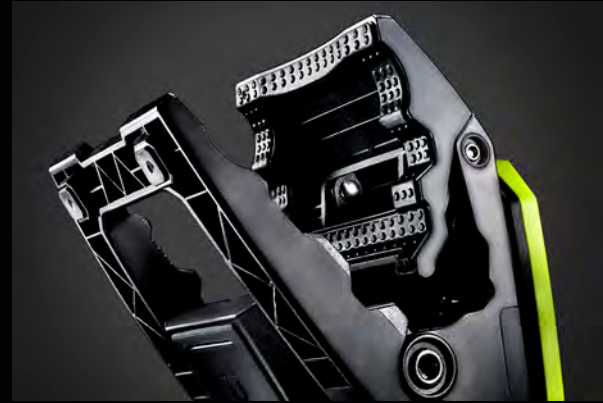

CL-1700 | HEAVY DUTY CLAMP WORK LIGHT

- 1700 Lumen 15W white 6500k COB LED
- Ultra tough nylon & TPE over-moulded housing
- Incredibly strong jaw clamp to attach almost anywhere
- Extra strong magnet on base with 4 non-slip rubber feet
- Clamp handles allow the lamp to stand-up in various positions
- Light head lifts up/down 270° & rotates around 340°
- Smart memory switch - remembers last used mode
- IK07 super tough construction
- Over-charge & over-discharge protection
- 3 battery level & charging indicators
- Low battery warning 3x flash - reminds to charge
- Supports 'PD' power delivery fast charging
- Faster 3A USB-C charging - 5 hour charge time
- 1m high quality USB-C cable included

BATTERY 3.7V 5200mAh Li-ion

WEIGHT 626.4g

DIMENSIONS 176 x 100 x 94mm



LUMEN 1700LM | RUNTIME 3-22H | BEAM 53M | IP RATING IP65/IK07

Information correct at time of going to press. Not all products are available in all regions.



aspenspumps.com | +44 (0)1323 848842 | sales@aspenspumps.com | UK 199

14

LIGHTING
& TORCHES

INSPECTION



PB-10050 | SUPER HEAVY-DUTY MAGNETIC POWER BANK WITH FLASHLIGHT

- High quality 3.6V 10050mAh internal Li-ion battery
- Intelligent multiple outputs via USB-A port, supporting fast charging (5V-2A / 9V-2A / 12V-1.5A)
- Fast 2A USB-C recharging - 4.5 hr charge time
- Over-charge, over-load, deep-discharge and short-circuit protection
- 3 Battery level & charging indicator LEDs
- Super tough nylon & TPR construction
- IK07 shock proof - 2m drop proof
- IP65 dust & water proof
- Super strong magnetic base
- Sturdy rear aluminium pocket clip
- 250 Lumen 6500k SMD LED flashlight
- With a massive 75hr runtime

BATTERY 3.6V 10050mAh Li-ion
WEIGHT 265g
DIMENSIONS 114 x 65 x 32mm

UNILITE

LUMEN 250LM | RUNTIME 75H | BEAM 21M | IP RATING IP65/IK07

Information correct at time of going to press. Not all products are available in all regions.



aspenspumps.com | +44 (0)1323 848842 | sales@aspenspumps.com | UK 200

14

LIGHTING
& TORCHES

INSPECTION

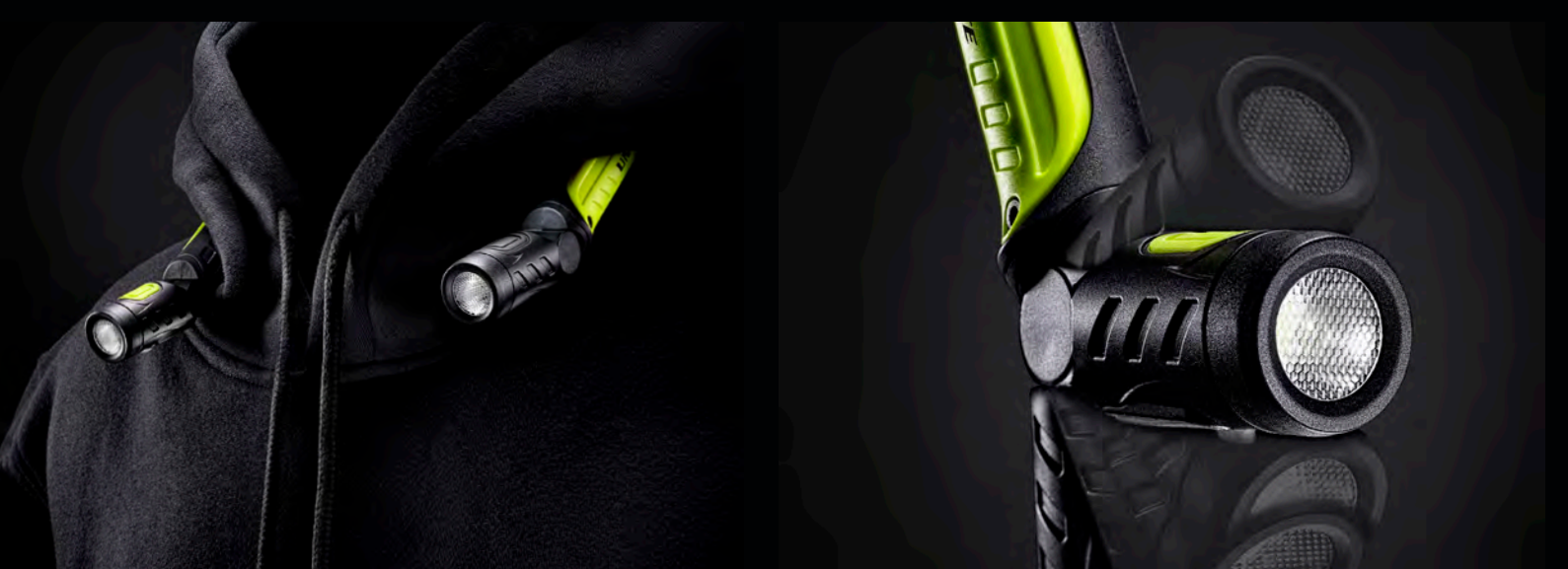

NL-350R | RECHARGEABLE NECK LIGHT

- High quality 350 lumen 6500k white SMD LEDs
- Super lightweight, adjustable and comfortable
- 2 light heads can be adjusted independently
- Super tough polycarbonate & ABS construction
- Up to 120° wider lighting angle
- IK07 Shock proof - 2m drop resistant
- IP54 Dust & water resistant
- Circuit protection prevents battery from over-charging or over-discharging
- High quality 3.7v 700mAh Li-ion battery
- 3 colour LED battery level indicator
- Charging indicator - Green flash: Charging / Green: Fully Charged
- Low battery 3x warning flash - reminds when charging is needed
- USB-C charging cable included - quick 2° hour charge time

BATTERY	3.7v 700mAh Li-ion
WEIGHT	140g
DIMENSIONS	230 x 150 x 23mm

 **UNILITE**

LUMEN 350LM | RUNTIME 2-10H | BEAM 45M | IP RATING IP54/IK07

Information correct at time of going to press. Not all products are available in all regions.



HL-4R | USB HELMET HEADTORCH

- 275 lumen white CREE LED, 6500k
- 2 x 5mm red LEDs for night vision - ON and FLASHING
- Red-to-Green charging indicator
- Easy push micro switch
- 45° rotational head
- Strong ABS housing
- Fully adjustable non-slip silicone headband
- 3M VHB adhesive helmet mount (included)
- 1m impact resistant
- Now Faster 1A USB-C charging - 2.5 hour charge time
- 1m USB-C charging cable included

BATTERY 3.7v 1800mAh Li-Polymer

WEIGHT 78g

DIMENSIONS headtorch 63 x 40 x 42mm



LUMEN 275LM | RUNTIME 6.5-170H | BEAM 95M | IP RATING IPX5

Information correct at time of going to press. Not all products are available in all regions.

14

LIGHTING
& TORCHES

HEAD TORCHES



HL-8R | DUAL BEAM SENSOR HEADTORCH

- 475 lumen white SMD LEDs, 6500k
- 2 x Side SMD LEDs for wide flood lighting
- 250 lumen SMD LED for long distance spot beam
- Sensor mode for hands-free operation
- Super tough construction with rubberised coating
- IK07 shock resistant
- IP65 dust & water resistant
- 1m impact resistant
- 60° rotational head
- Fully adjustable non-slip silicone lined headband
- Red-to-Green charging indicator light
- Fast 1A USB-C rechargeable - 2.5 hours charge time
- 1m USB-C charging cable included

BATTERY 3.7v 1500mAh Li-Polymer
WEIGHT 111g
DIMENSIONS headtorch 47.5 x 78.5 x 46mm



LUMEN 475LM | **RUNTIME** 4-35H | **BEAM** 90M | **IP RATING** IP65/IK07

Information correct at time of going to press. Not all products are available in all regions.

14

LIGHTING
& TORCHES

HEAD TORCHES



HT-700 | SENSOR HELMET HEADTORCH WITH RGB LED

- High power 700 lumen Dual white 6500k Cree LEDs
- White spot beam & flood beam LEDs
- Red/Green/Blue LED for night vision/map reading/signalling
- With red flashing mode for emergency
- 150° Rotating head angle
- Smart Memory - remembers last white mode used
- Press & hold smooth dimming on white modes
- Optional motion sensor for hands-free activation
- IP65 Dust & water resistant
- Adjustable non-slip silicone lined headband included
- 3M VHB Adhesive helmet mount included
- Hard-shell protective zipped storage case included
- Useful battery level & charging indicator under switch
- 30cm High quality USB-C Charging cable included
- USB-C 5V-1A charging - 4 hr charge time
- 1 x 3.6V 18650 3400mAh Li-ion battery included with bi-directional USB-C port
- Battery can easily be removed & replaced, and used as an independent powerbank

BATTERY 1 x 3.6V 18650 3400mAh Li-ion Battery
WEIGHT 121g (Headtorch with battery, no strap)
DIMENSIONS Headtorch L 50.65 x W 79.5 x H 39.5mm

 **UNILITE**

LUMEN 700LM | RUNTIME 5.5-170H | BEAM 70M | IP RATING IP65

Information correct at time of going to press. Not all products are available in all regions.

14

LIGHTING
& TORCHES

HEAD TORCHES



HT-1600R | SUPER BRIGHT POWERBANK HEADTORCH

- Super bright 1600 lumen 6500k white LEDs
- Easy twist smooth dimming switch
- White spot beam & flood beam LEDs
- Red LEDs for night vision & emergency/signalling
- 60° Rotating head angle
- Adjustable non-slip silicone lined headbands
- Smart Memory - remembers last white mode used
- IPX5 water resistant
- Hard-shell protective zipped storage case included
- 1m High quality USB-C Charging cable included
- 2 x 21700 5000mAh Li-ion batteries
- Parallel circuitry (can run on 1 or 2 batteries)
- Useful battery level & charging indicators
- Fast 5V-3A USB-C charging - 5 hr charge time
- Battery pack can be completely detached & used as an independent powerbank (5V-3A output)
- Each 21700 battery is also its own independent power bank

BATTERY 2 x 3.7v 21700 5000mAh Li-ion

WEIGHT 392g (with 2 batteries)

DIMENSIONS Headtorch H 40 x W 65 x D 35.5mm / Battery pack H 50 X W 106 X D 30mm



LUMEN 1600LM | RUNTIME 8-38H | BEAM 128M | IP RATING IPX5

Information correct at time of going to press. Not all products are available in all regions.

14

LIGHTING
& TORCHES

FLASH LIGHTS



F-1400 | DUAL POWER ALUMINIUM FLASHLIGHT

- High quality 1400 lumen white LED, 6500k
- Hard anodized die cast matte aluminium body
- Tactical rubberised tail switch
- 4 light modes and 8Hz defence strobe
- Flawless smooth reflector for long distance beam
- IP68 dust and waterproof - 1m submersible
- Impact resistant to 2m
- Built-in concealed USB-C charging port
- Battery level and charging indicator LED
- Circuit Protection prevents battery from over-charging or over-discharging
- Fast 1A USB-C charging - 2.5 hour charge time
- High quality USB-C charging cable inc. (0.5m)
- Can also work with 2 x CR123A lithium batteries (not inc.)
- Safety nylon wrist strap included

BATTERY 3.6V 2600mAh 18650 Li-ion (inc.) / or 2 x CR123A batteries (not inc.)

WEIGHT 157g (with li-ion battery) / 109g (without battery)

DIMENSIONS 140 x Ø 30x Ø 25mm



LUMEN 1400LM | RUNTIME 2.5-23H | BEAM 180M | IP RATING IP68

Information correct at time of going to press. Not all products are available in all regions.



aspenspumps.com | +44 (0)1323 848842 | sales@aspenspumps.com | UK 206

14

LIGHTING
& TORCHES

FLASH LIGHTS



FR-1200 | DUAL POWER RIGHT ANGLE FLASHLIGHT

- High quality 1200 lumen white LED, 6500k
- Hard anodized die cast matte aluminium body
- Head rotates to 90-degree angle
- Useful pocket clip and strong magnetic base
- Rubberised easy press side switch
- 3 light mode settings
- Flawless smooth reflector for long distance beam
- IP65 dust and water resistant
- Impact resistant to 2m
- Built-in rubberised USB-C charging port
- Battery level and charging indicator under the switch
- Circuit Protection prevents battery from over-charging or over-discharging
- Fast 1A USB-C charging - 2.5 hour charge time
- High quality USB-C charging cable inc. (0.5m)
- Can also work with 2 x CR123A lithium batteries (not inc.)

BATTERY 3.6V 2600mAh 18650 Li-ion (inc.) / or 2 x CR123A batteries (not inc.)

WEIGHT 209g (with li-ion battery) / 161g (without battery)

DIMENSIONS Extended length 160.5 x Ø 30x Ø 27mm

 **UNILITE**

LUMEN 1200LM | RUNTIME 3-14H | BEAM 180M | IP RATING IP65

Information correct at time of going to press. Not all products are available in all regions.

14

LIGHTING
& TORCHES

ATEX



ATEX-RA2 | ZONE 0 INTRINSICALLY SAFE RIGHT ANGLE TORCH

- 350 lumen white CREE LED, 6500k
- ATEX Zone 0 gas compliant
- Suitable for mining
- Safety release valve to release hydrogen gases
- Chemical and corrosion resistant
- Ultra strength polycarbonate housing
- Rubberised head and grips for durability
- Convenient rear stainless steel pocket clip
- Safety locking battery compartment
- Easy push micro switch operation
- IP54 dust and water resistant

BATTERY 4 x 1.5V AA Alkaline Batteries (not inc.)
WEIGHT 250g (without batteries)
DIMENSIONS 183 x 69 x 63mm



UNILITE

LUMEN 350LM | RUNTIME 6.5-13H | BEAM 288M | IP RATING IP54

Information correct at time of going to press. Not all products are available in all regions.



aspenspumps.com | +44 (0)1323 848842 | sales@aspenspumps.com | UK 208

14

LIGHTING
& TORCHES

ATEX



ATEX-FL4 | ZONE 0 INTRINSICALLY SAFE FLASHLIGHT

- 150 lumen white CREE LED, 6500k
- ATEX Zone 0 gas compliant
- Safety release valve to release hydrogen gases
- Chemical and corrosion resistant
- Rubberized head & handle for greater durability
- Industrial strength polycarbonate housing
- Detachable pocket clip included for hands free use
- Safety locking battery compartment
- Polycarbonate lens and smooth reflector for long distance beam
- Optional brackets available for helmets
- IP67 dust and waterproof
- 3m submersible

BATTERY 4 x 1.5V AA Alkaline Batteries (not inc.)
WEIGHT 115g (without batteries)
DIMENSIONS 174 x 47 x 47mm



UNILITE

LUMEN 150LM | RUNTIME 6-69H | BEAM 235M | IP RATING IP67

Information correct at time of going to press. Not all products are available in all regions.



ATEX-H2 | ZONE 0 INTRINSICALLY SAFE HEADTORCH

- 225 lumen white CREE LED, 6500k
- ATEX Zone 0 gas compliant
- Safety release valve to release hydrogen gases
- Strong ABS housing with durable synthetic rubber coating
- Safety locking battery compartment
- Easy press rubberised switch
- 2 mode light settings
- 90° rotational head
- Silicone lined non-slip headband included
- IP67 dust and waterproof
- 1m submersible

BATTERY 3 x 1.5V AAA Alkaline Batteries (not inc.)
WEIGHT 130g (without batteries)
DIMENSIONS headtorch 80 x 50 x 45mm



LUMEN 225LM | RUNTIME 5-12H | BEAM 115M | IP RATING IP67

Information correct at time of going to press. Not all products are available in all regions.

Safety Glasses	212-214
Cut & Impact-Resistant Gloves	215
Zipped Jumpers	216

16 PPE



16

PPE

SAFETY GLASSES



SG-YFG | SAFETY GLASSES WITH CLEAR LENSES & FOAM GASKET

- Tough flexible polycarbonate frame
- 8-Base curved toughened polycarbonate clear lenses
- Hytrel black back frame with EVA foam gasket
- K & N anti-scratch & anti-fog lens coatings
- 99% UV A/B/C protection (EN170)
- Flexible PC & TPR co-injected side arms
- With side temple ventilation
- Adjustable TPR non-slip nose pads
- Reinforced nose bridge
- Micro-fibre drawstring storage bag included

LENS MARKINGS

- Lens Filters: 2C (UV EN170) 1.2 (Clear)
- Optical Class: 1 (high optical quality)
- Lens Coatings: Anti-Scratch - K Anti-Fog - N
- Mechanical risk: Low energy impact - F
- High speed particles at extreme temperatures - T

WEIGHT 39.5g



CERTIFICATIONS CE - EN166 / USA - ANSI Z87.1 / AUS/NZ - AS/NZS 1337.1

Information correct at time of going to press. Not all products are available in all regions.

16

PPE

SAFETY GLASSES

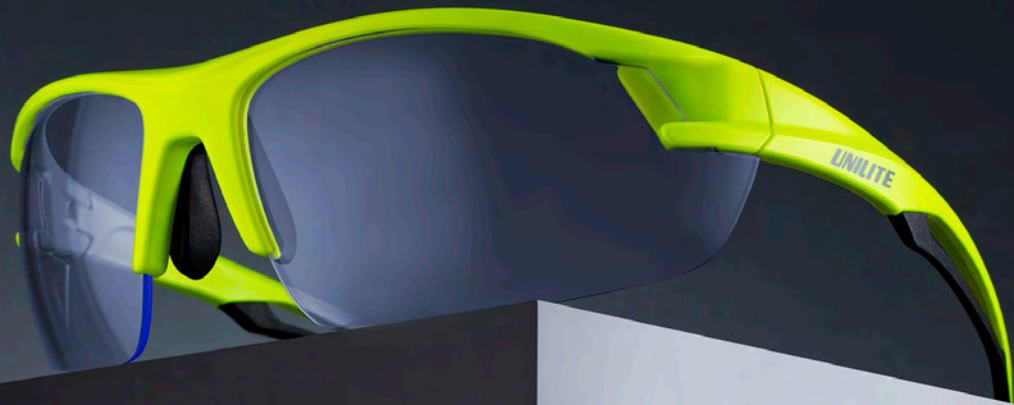

SG-YCB | SAFETY GLASSES WITH CLEAR BLUE LIGHT LENSES

- Tough flexible polycarbonate frame
- 8-Base curved toughened polycarbonate lenses
- Clear 420Cut blue light blocking lenses
- Blocks harmful HEV blue light up to 420nm
- K & N anti-scratch & anti-fog lens coatings
- 99% UV A/B/C protection (EN170)
- Flexible PC & TPR co-injected side arms
- Adjustable rubberized non-slip nose pads
- Reinforced nose bridge
- Micro-fiber drawstring storage bag included

LENS MARKINGS

- Lens Filters: 2C (UV EN170) 1.2 (Clear)
- Optical Class: 1 (high optical quality)
- Lens Coatings: Anti-Scratch - K Anti-Fog - N
- Mechanical risk: Low energy impact - F
- High speed particles at extreme temperatures - T

WEIGHT 1oz



CERTIFICATIONS CE - EN166 | USA - ANSI Z87.1 | AUS/NZ - AS/NZS 1337.1

Information correct at time of going to press. Not all products are available in all regions.

16

PPE

SAFETY GLASSES

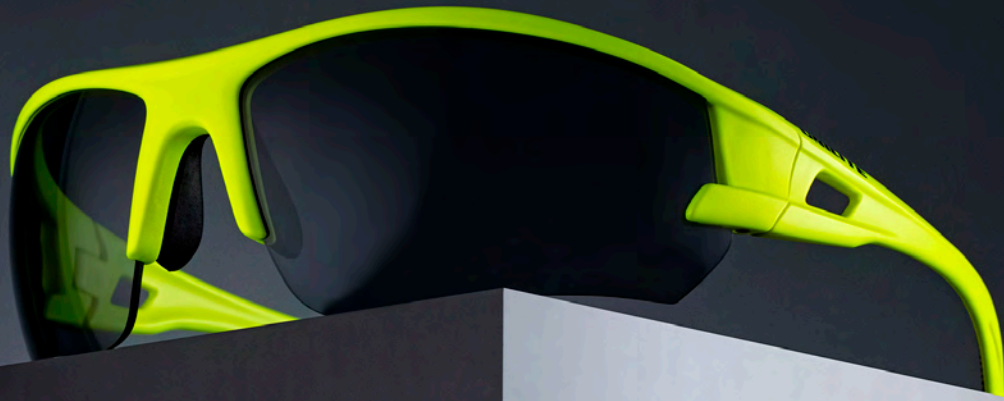

SG-YDS | SAFETY GLASSES WITH DARK SMOKE LENSES

- Tough flexible polycarbonate frame
- 8-Base curved toughened polycarbonate lenses
- Dark smoke lens tinting
- K & N anti-scratch & anti-fog lens coatings
- 99% UV A/B/C protection (EN172)
- Flexible PC & TPR co-injected side arms
- Side temple ventilation
- Adjustable rubberised non-slip nose pads
- Reinforced nose bridge
- Micro-fibre drawstring storage bag included

LENS MARKINGS

- Lens Filters: 5 (UV EN172) 2.5 (Dark Smoke)
- Optical Class: 1 (high optical quality)
- Lens Coatings: Anti-Scratch - K Anti-Fog - N
- Mechanical risk: Low energy impact - F
- High speed particles at extreme temperatures - T

WEIGHT 28g



CERTIFICATIONS CE - EN166 / USA - ANSI Z87.1 / AUS/NZ - AS/NZS 1337.1

Information correct at time of going to press. Not all products are available in all regions.



aspenspumps.com | +44 (0)1323 848842 | sales@aspenspumps.com | UK 214



		S/7	M/8	L/9	XL/10	XXL/11
Longest finger length to cuff	Inches	9	9 ½	10	10 ¼	10 ½
	CM	22.5	24	25	26	27
Palm width at the Knuckles	Inches	3 ¼	3 ½	3 ½	4	4
	CM	8.5	8.75	9	10	10.5

there may be variances in measurements due to hand cutting & stitching

UG-12C4 | HEAVY DUTY CUT-D IMPACT GLOVES

- Cut resistant gloves with full dorsal TPR impact protection
- Flexible lightweight design, TPR weighs less than 60g
- Heavy duty 15-Gauge high-performance polyethylene (HPPE) yarn interwoven with steel and glass fibres for added strength and high cut resistance
- Sandy nitrile half-dip coating offers excellent grip
- TPR is sonic welded to the glove for greater longevity
- Adjustable TPR velcro wrist strap for secure fit
- Synthetic leather stitched cuff for durability
- Touch screen technology
- EN388 mechanical hazard protection: 4X42DP - cut level D
- ANSI/ISEA 138 impact resistant level 2
- ANSI cut resistant level A4
- Available in 5 EU sizes - 7/S, 8/M, 9/L, 10/XL & 11/XXL.

EN388



4X42DP

ANSI



CUT

ANSI/ISEA 138



CERTIFICATIONS EN ISO 21420:2020 | EN388:2016+A1:2018 | ANSI/ISEA 2016 | ANSI/ISEA138:2019

Information correct at time of going to press. Not all products are available in all regions.

16

PPE

CLOTHING



ZFJ | FLEECE LINED JUMPER

- 260gsm Thick 100% polyester black zipped jumper
- Soft brushed fleece lining for superior warmth
- Hi-vis yellow and reflective details for added safety
- Elastic zip pull tabs ensure effortless access, making it a breeze to reach for your essentials on the go
- Unilite branded YKK 'reversed' zippers, delivering a double dose of water and wind resistance
- Windbreaker flap on main zip, creating an impenetrable barrier against chilling gusts
- Branded reflective elasticated cuffs to keep the cold out, fusing practicality with style

		S	M	L	XL	2XL	3XL
Chest Size	Inches	39 ½	41	43	45 ½	48	50
	CM	100	104	109	115	121	127

there may be a 1-3cm difference in measurements due to hand cutting

 **UNILITE**

Information correct at time of going to press. Not all products are available in all regions.



The Brands

Making life easier for the HVAC/R engineer

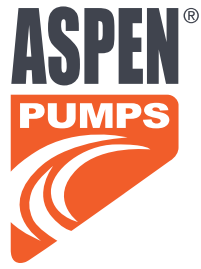

Aspen Pumps are at the forefront of condensate pump technology. As engineers, we understand the complexity of installations and so create market leading products that are designed to best suit the application and environment. We pride ourselves on providing professionals with everything they need for the perfect installation; from pumps to pipe we have it all.



Information correct at time of going to press. Not all products are available in all regions.



Aspen Xtra represents the largest range of installer ancillaries on the market – from Isolators to pipe connectors, wall brackets to vinyl tubing – whatever you need, reach for Xtra.



Information correct at time of going to press. Not all products are available in all regions.



2 Emme Clima was founded in Italy in 2008 and, thanks to its expertise, quickly became one of the largest companies in the air conditioning sector. The company is represented both on the Italian market and worldwide and specialises in the production of support brackets and accessories for condensing units. With the integration of a paint shop, 2 Emme Clima became the first company in Europe with a complete production process. To date, over 1,000,000 wall brackets have been produced and sold, making 2 Emme the preferred choice for installers in Europe. In 2022, 2 Emme Clima joined the Aspen Pumps Group family of brands.



Information correct at time of going to press. Not all products are available in all regions.



Vecamco is an Italian company with over 40 years of experience in the processing of plastics and metals. Specialised in the production of accessories for air conditioning, heating, and components for ventilation and air treatment. Over the years, Vecamco has quickly established itself as a leading company both nationally and internationally in this sector, offering a wide range of products known for their high quality and continuous innovation. These attributes are the result of ongoing research aimed at meeting customer needs and developing efficient, modern, and innovative solutions. In 2022, Vecamco became part of Aspen Pumps Group.



Information correct at time of going to press. Not all products are available in all regions.



Advanced

Joining the Aspen Pumps Group in 2018, Advanced is the recognised market leader in specialist HVAC/R cleaning chemicals. The research and development team at Advanced has created a range of chemical cleaning products designed to give optimum cleaning performance across a variety of applications and environments. Trusted by engineers to do the job right, Advanced has been supplying products to the HVAC/R industry for over 30 years.



Information correct at time of going to press. Not all products are available in all regions.



The JAVAC brands have a proud heritage of supplying quality and premium tools to the HVAC/R industry. The devil is in the detail and for over 50 years the JAVAC brand has stood for reliability and service – making JAVAC, and JAVAC Edge, one of the UK's most trusted names in HVAC/R service equipment. As part of the Aspen Pumps Group, our focus is on products which make the installer's life easier.



Photo credit: Top left clockwise: @godfreyIappage, @hvac_spark, @temp_technical, @temp_technical, @hvac_spark

Information correct at time of going to press. Not all products are available in all regions.



SPECTROLINE®

Spectroline has over 65 years designing and manufacturing high-quality fluorescent leak detection dyes and ultraviolet lamps. Our dyes glow brighter than the competition and is a simple and smart investment for detecting leaks whilst working as preventative maintenance revealing leaks in the future. Aspen Pumps Group are a proud and exclusive distributor of Spectroline in the UK.



Information correct at time of going to press. Not all products are available in all regions.

C&D VALVE

C&D Valve is a well-established US manufacturer of valves and fittings, with a strong reputation in the HVAC/R sector.

Established in 1967 in Oklahoma City, C&D continues to offer unrivalled product quality and service. Recently acquired by the Aspen Pumps Group, a leading global manufacturer of air conditioning and refrigeration aftermarket products, C&D marks an important step in Aspen's UK manufacturing and sales capabilities.



Information correct at time of going to press. Not all products are available in all regions.



Unilite has built lights tough since 1981. The range back then was limited to just a handful of product lines. Wind the clock forward 43 years and now there are over 125 products, all with the same Built. Tough. DNA.



Information correct at time of going to press. Not all products are available in all regions.



The toughest and most versatile tool bag you'll ever own. Maximised tool storage capacity – you will never be short on space. Waterproof base, double stitched, heavy duty plastic coil over sized zips. Industrial strength double nylon stitching. D-Rings: Powder coated steel. Zinc/marine grade press studs. Gun metal/marine grade rivets. Wheels, backpacks, open tops, pouches. Aspen Pumps Group are proud to deliver these superb bags designed for the HVAC/R technician.



Photo credit: Top left clockwise: Veto Pro Pac, BassFilmco/Epic Air, @alstoolchannel.

Scan me for the full range of Veto Bags. vetopropac.com



Information correct at time of going to press. Not all products are available in all regions.



Our aim at Big Foot Systems continues to be 'to provide easy to assemble rooftop building services support systems'. Our range of products provide quick, simple, safe and versatile solutions for the support of rooftop HVAC/R equipment, and access platforms.

Big Foot Systems sets the standard on any installation, meeting the needs of architects, consultants, engineers and contractors. Big Foot products are packed for ease of handling and available internationally via a network of approved distributors.

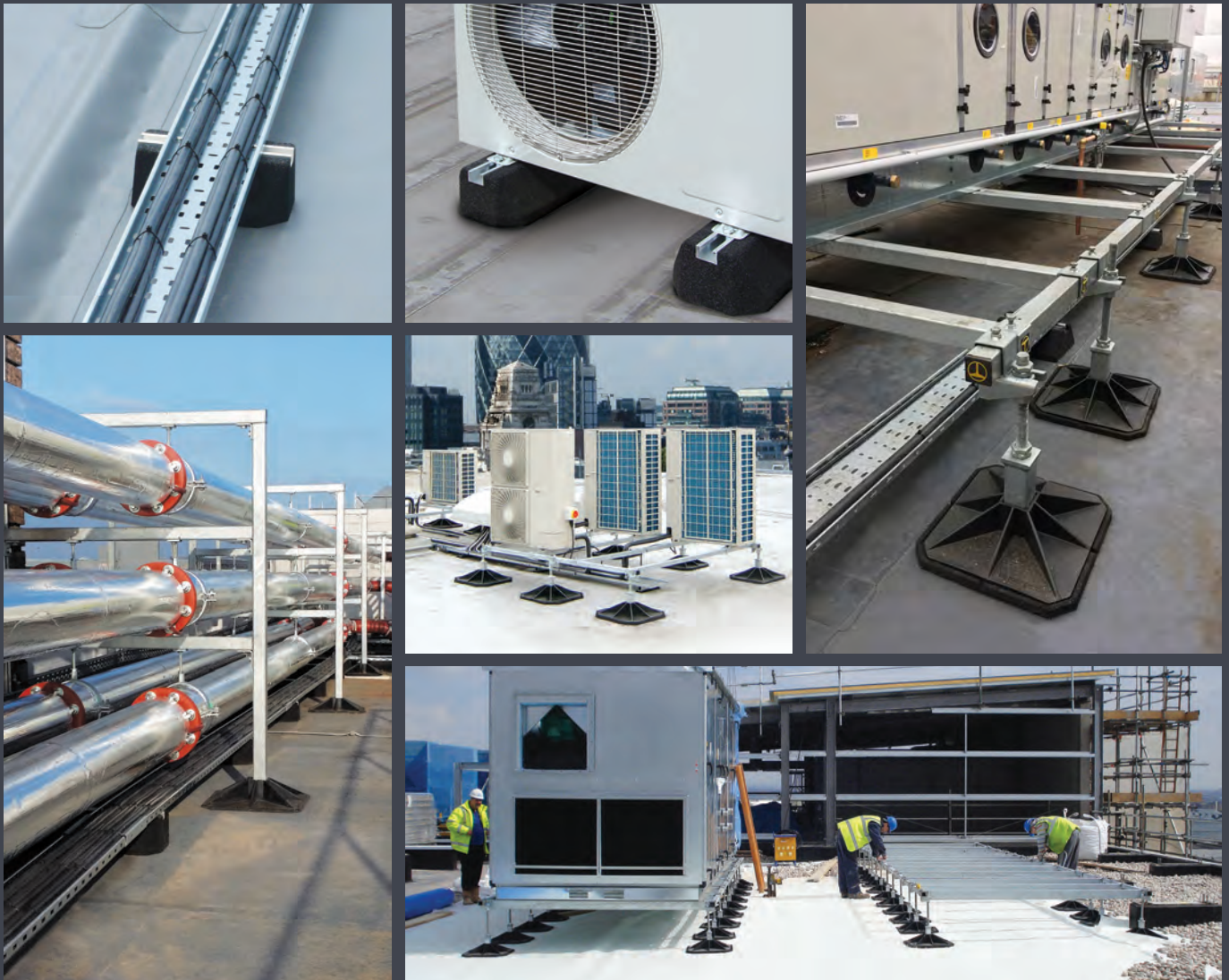

Information correct at time of going to press. Not all products are available in all regions.

SOLFLEX

Acoustic solutions

Solflex, designer and supplier of high-quality acoustic insulation solutions, reduces noise emissions from your air conditioning, refrigeration or heat pump installations to negligible levels without limiting their functionality. Whether you need to comply with regulatory and planning requirements or simply reduce noise levels for yourself or your neighbours, we have a product for you.

We offer packaged solutions for simple installations through to complex bespoke solutions and can assist installers, wholesalers, design offices, consultants, architects, as well as private and commercial building owners and facility operators.

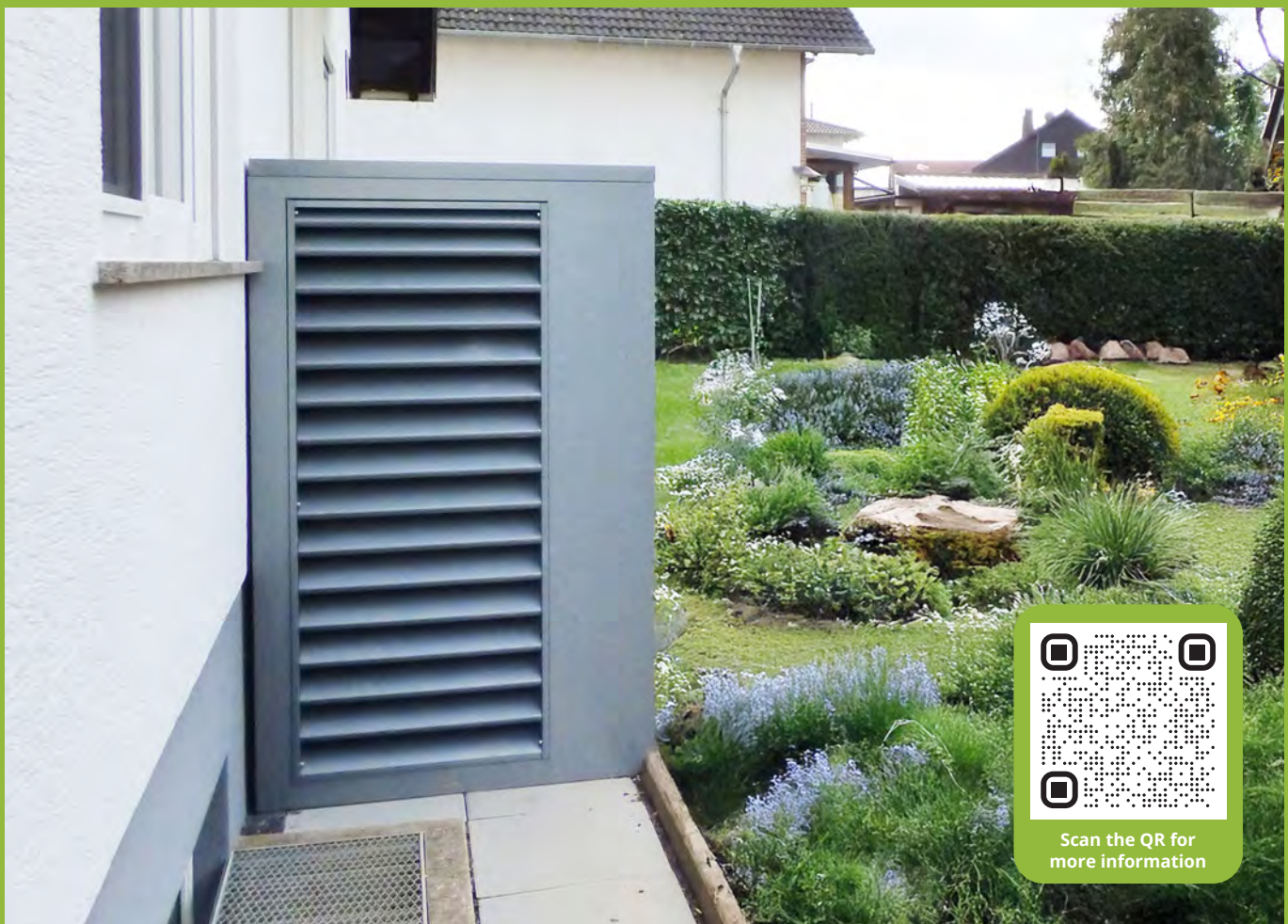

The sound insulation performance of our acoustic enclosures is measured by the Ziehl-Abegg laboratory in accordance with DIN EN ISO 3744.

Information correct at time of going to press. Not all products are available in all regions.



aspenspumps.com

ITALY

Aspen Pumps Italia
Via dell'industria 17,
35030 Bastia di Rovolon (PD) - Italy
Tel: +39 049-9903985

UNITED KINGDOM

Aspen Pumps Group
Apex Way, Hailsham,
East Sussex BN27 3WA, UK
Tel: +44 (0)1323 848842

GERMANY

Aspen Pumps Deutschland
Tichauer Weg 30,
40231 Düsseldorf, Germany
Tel: +49 0211 46 79 79

INDIA

Aspen Pumps India
333, 3rd Floor Devika Tower,
6 Nehru Place, Delhi 110019, India
Tel: +44 (0)1323 848842 (UK Office)

SPAIN

Aspen Pumps Iberia
C/Óptica, 10, 08755 Castellbisbal,
Barcelona, Spain
Tel: +34 93 5458616

FRANCE

Aspen Pumps France
353, Allée des Vergers,
76360 Barentin, France
Tel: +33 (0)1 78 95 88 82

AUSTRALASIA

Aspen Pumps Asia Pacific Pty Ltd
8 Waddikee Rd, Lonsdale,
SA 5160, Australia
Tel: +61 (0)8 8186 4666

NORTH AMERICA

The Malco Group
14080 State Hwy 55 NW | PO Box 400
Annandale, MN 55302-0400 USA
Tel: 1-800-328-3530